

KPC-3

Reference Manual

Kantronics

RF Data Communications Specialists

1202 E. 23rd Street, Lawrence, Kansas 66046

Order number (913) 842-7745

Service / Technical Support (913) 842-4476

9 am - noon, 2 pm - 5 pm Central Time, Monday-Friday

FAX number (913) 842-2021

BBS number (913) 842-4678 300 - 14,400 (MNP, V.32BIS) N,8,1
24 Hour Operation

The KPC-3 is a Kantronics hardware and software design incorporating the AX.25 Level 2 Version 2 Packet protocol as adopted by the American Radio Relay League. This manual contains information from earlier KPC-1, KPC-2, KPC-2400, KPC-4, and KAM manuals and addendums, modified as appropriate. In addition, Kantronics acknowledges the use of material from the original Tucson Amateur Packet Radio Corporation (TAPR) TNC-1 manual granted by OEM agreement.

We have attempted to make this manual technically and typographically correct as of the date of the current printing. Production changes to the TNC may add errata or addendum sheets. We solicit your comments and/or suggested corrections. Please send to Kantronics Co., Inc., 1202 E. 23rd Street, Lawrence, KS 66046.

Printed in the U.S.A.

© Copyright 1988-1992 by Kantronics Co., Inc. All rights reserved.

Contents of this publication or the firmware described herein may not be reproduced in any form without the written permission of the copyright owner.

NET/ROM is a registered trademark of SOFTWARE 2000

Commodore, C-64, and C-128 are trademarks of Commodore Business Machines, Inc.

Apple and Macintosh are registered trademarks of Apple Computer, Inc.

READ THIS PAGE BEFORE YOU INSTALL THE PRODUCT ASSOCIATED WITH THIS MANUAL

The product with which this manual is associated contains SOFTWARE on Programmable Read Only Memory (PROM) which is protected by both United States copyright law and international treaty provisions.

If you install or use the product associated with this manual, you will be deemed to be bound by the terms of the SOFTWARE license shown below. If you do not wish to be bound by such license, return such product and all associated documentation unused to your supplier for refund of the amount you paid.

License Agreement

1. License. In consideration of payment of the License Fee, which is included in the price of the product, the Licensee (you) is granted by the Licensor (Kantronics Company, Inc. – Kantronics) a non-exclusive right to use the SOFTWARE and associated documentation. No ownership rights to the SOFTWARE or its Documentation are transferred from Kantronics to you.

2. Term. This License Agreement is effective until terminated. You may terminate this Agreement by destroying the PROM and documentation. You may not rent or lease the SOFTWARE, but you may transfer the SOFTWARE and accompanying written materials on a permanent basis provided you retain no copies and the recipient agrees to the terms of this Agreement. Kantronics may terminate this Agreement without notice if you violate any terms or conditions of the Agreement. In the event of termination of the Agreement, provisions relating to Kantronics' disclaimers of warranties, limitation of liability, remedies, or damages and Kantronics' proprietary rights shall survive.

3. Object Code. The SOFTWARE is delivered in object code only. You shall not reverse compile or otherwise reverse engineer the SOFTWARE.

4. Limited Warranty. Kantronics warrants that the media on which the SOFTWARE and Documentation are furnished will be free from defects in materials and workmanship under normal use for a period of one (1) year from the date you take possession of the SOFTWARE and Documentation. Your exclusive remedy under this Limited Warranty is the replacement of any defective physical media on which the SOFTWARE or Documentation is furnished. To receive such replacement, return the defective media to the supplier during the Warranty Period, with proof of payment.

Except as provided above, THE SOFTWARE AND DOCUMENTATION IS PROVIDED "AS IS," WITHOUT WARRANTY OF ANY KIND, EITHER EXPRESSED OR IMPLIED. Kantronics disclaims the implied warranty of merchantability and the implied warranty of fitness for a particular purpose. Kantronics does not warrant that the functions contained in the SOFTWARE will meet your requirements or achieve your intended results; or that operation of the SOFTWARE will be uninterrupted or error-free or without effect upon other SOFTWARE used with it. Responsibility for the selection of the SOFTWARE program to achieve your intended results rests with you.

This Limited Warranty gives specific legal rights, and you may also have other rights which vary from state to state.

5. Limitation of Liability. Kantronics' sole obligation or liability under this agreement is the replacement of defective media in accordance with the Limited Warranty.

In no event will Kantronics be liable for any consequential, incidental or indirect damages or for any claim by any third party, even if Kantronics has been advised of the possibility of any such damages.

6. General. This License Agreement constitutes the complete Agreement between you and Kantronics.

The SOFTWARE and/or Documentation may not be exported or re-exported in violation of any export laws or regulations of the United States of America or any other applicable jurisdiction.

This Agreement shall be governed by and interpreted under the laws of the State of Kansas, United States of America.

Use, duplication, or disclosure by the Government of the United States is subject to restrictions as set forth in subparagraph (c)(1)(ii) of the Rights in Technical Data and Computer SOFTWARE clause of DFARS 252.227-7013.

Kantronics may in its sole discretion, provide you with upgrades of the SOFTWARE and/or Documentation if you have provided Kantronics your completed Warranty registration with a copy of your receipt showing the amount you paid.

LICENSEE ACKNOWLEDGES THAT IT HAS READ AND UNDERSTANDS THIS AGREEMENT AND AGREES TO BE BOUND BY ITS TERMS. LICENSEE FURTHER AGREES THAT THIS AGREEMENT IS THE COMPLETE AND EXCLUSIVE STATEMENT OF THE AGREEMENT BETWEEN LICENSEE AND LICENSOR AND SUPERSEDES ANY PROPOSAL OR PRIOR AGREEMENT, ORAL OR WRITTEN, AND ANY OTHER COMMUNICATIONS RELATING TO THE SUBJECT MATTER OF THIS AGREEMENT.

Any questions concerning this Agreement or any other matter relating to Kantronics Company, Inc. products or business practices may be directed to:

Customer Service Department
Kantronics Company, Inc.
1202 E. 23rd Street
Lawrence, KS 66046

Table of Contents

Limited Warranty	1
Return/Repair Procedures	2
Radio Frequency Interference.....	3
Precautions.....	5
Preface	6

Commands

Introduction to Commands.....	8
Commands.....	11

Operations

Packet Mode	51
PBBS (Personal Mailbox)	62
KA-Node	73
Remote Access to Your KPC-3.....	81
Kantronics Host Mode Operation	83
WEFAX Mode.....	86
KISS Mode.....	90

Installation

Connecting the KPC-3 to Your Computer.....	93
Connecting Your Radios.....	97
AFSK Output Level	99
Interfacing Hand-Held Radios	100
In Case of Difficulty.....	102
Assembly and Disassembly of the KPC-3.....	104
Hard Reset	105
Calibration/Equalization	106
Watch Dog Timer	107
Jumper Definitions	108

Options for the KPC-3.....	110
Specifications.....	112
Display Listings	113
Messages From the KPC-3	115
ASCII Chart	121
KPC-3 Parts List.....	123
KPC-3 Parts Layout.....	125

Limited Warranty

Kantronics Company, Inc. warrants to the first consumer purchaser, for a period of one year from the date of purchase, that this product will be free from defects in material and workmanship, and agrees that it will, at its option, repair or replace the defective parts or the product at no charge for parts or labor.

This warranty does not apply to the cosmetic appearance of the product, or to any product that has been subject to misuse, abuse, overvoltage, or other cause beyond our reasonable control.

This warranty does not apply to any unit that has been modified by the consumer unless specifically authorized by Kantronics Company, Inc, in writing.

In no event shall Kantronics be held liable for damages due to fire, flood, civil disobedience, riot, acts of God or damages incurred in shipping due to poor packaging. Kantronics shall not be held liable in the event the defect is found to be caused by improper parameter settings which are cleared by performing a hard reset.

Kantronics shall not be liable for any incidental or consequential damages arising from the use of the product or due to the non-availability for use of the product under any circumstances.

Some States do not allow the exclusion or limitation of incidental or consequential damages, so the above limitation or exclusion may not apply to you.

In order to enforce the rights under this limited warranty, the purchaser should mail, ship or carry the product, together with proof of purchase, to Kantronics Company, Inc, 1202 East 23rd Street, Lawrence, Kansas 66046. The consumer must also provide adequate proof of purchase indicating the date the product was purchased.

There are no other warranties, including the implied warranty of fitness for a particular purpose, not specified herein with regards to this product. Neither the sales personnel of the seller nor any other person is authorized to make any warranties other than those described herein, or to extend the duration of any warranties beyond the time period described above.

This warranty is not assignable by the original consumer. Any attempt to assign or transfer any of the rights, duties or obligations hereof is void.

Any product returned for warranty service and our inspection and testing shall determine no defect exists which is covered by this warranty, shall be charged a minimum of one-half hour labor plus return shipping charges.

This warranty gives you specific legal rights and you may also have other rights which vary from State to State.

Return/Repair Procedures

Consult the limited warranty policy in this manual for the service provisions offered by Kantronics at no charge. This warranty is considered to be in force only when the customer has submitted his completed warranty registration within 10 days of purchase, and when the stipulations of the warranty have been met. Violations of warranty clauses will automatically void the warranty and service or repairs will be charged to the owner.

Service outside the warranty will be charged at the cost of parts, labor, and return shipping. Units returned for service without a Return Authorization number will be subject to a minimum charge of 1/2 hour labor plus shipping and handling. Contact the Service Department (913-842-4476) to obtain a Return Authorization number. Repaired units will be returned via UPS C.O.D. These C.O.D. charges can be avoided by including your VISA or MasterCard number with your unit to be repaired. Shipping and repair may then be charged.

When service or repairs appear necessary, it may be wise to call or write Kantronics to determine if the problem can be solved without returning the unit. Should you encounter difficulty in getting your KPC-3 to "talk" to your computer, you may wish to perform some limited checks before calling or writing. Carefully check your wiring connections to the RS-232 port. Verify your terminal baud rate. It may be useful to perform a "Hard Reset". (See Hard Reset section.)

When calling, report the product name and ask for the Amateur Radio Service Department. Should you find it necessary to call for assistance, please have the following information available:

1. The unit name and serial number (the serial number is found on the rear panel.)
2. The firmware version number (the version number is displayed when you give the Version command.)

If possible, you should have the KPC-3 and your computer available to perform troubleshooting operations when you call.

The Service Department telephone hours are 9 am - noon and 2 pm - 5 pm
Central Time 913-842-4476, Monday through Friday.

When writing, include a clear description of the problem, unit name, computer type, computer software used and if possible a DISPLAY listing from the KPC-3.

Returns to the factory for refund or exchange are strictly regulated. Any return for refund or exchange must be approved by the service department.

Radio Frequency Interference Statement

INFORMATION TO THE USER

NOTE: This equipment has been tested and found to comply with the limits for a Class B digital Device, pursuant to Part 15 of the FCC Rules. These limits are designed to provide reasonable protection against harmful interference in a residential installation. This equipment generates, uses and can radiate radio frequency energy and, if not installed and used in accordance with the instructions, may cause harmful interference to radio communications. However, there is no guarantee that the interference will not occur in a particular installation. If this equipment does cause harmful interference to radio or television reception, which can be determined by turning the equipment off and on, the user is encouraged to try to correct the interference by one or more of the following measures:

- Reorient or relocate the receiving antenna.
- Increase the separation between the equipment and receiver.
- Connect the equipment into an outlet on a circuit different from that to which the receiver is connected.
- Consult the dealer or an experienced Radio/TV technician for help.

The user is cautioned that any changes or modifications not expressly approved by the party responsible for compliance could void the user's authority to operate the equipment.

The user is also cautioned that any peripheral device installed with this equipment must be connected with a high-quality shielded cable to insure compliance with FCC limits.

RFI Suppression

In moving to the world of digital communications via computers, a new dimension of RFI may be encountered. In spite of the equipment manufacturers' diligence, each new piece of electronic equipment will react differently in each separate environment. Every amateur station will have its own unique layout, equipment variation, and antenna installations. Experience has shown that these differences are related to the total RF environment, and may be causative factors in RFI induced problems. The suggestions given here may assist in resolving RFI problems you may encounter in your "unique" station.

1. Use shielded cable for all connections between equipment.
2. Make all interconnecting cables as short as practical. A balance should be maintained between cable length and equipment proximity. At times simply moving the video monitor one foot further from an interface or other device will solve the "screen hash" problem.
3. Antenna runs should be kept away from equipment control lines and/or interconnecting cables. If it is necessary for such lines to cross each other they should do so at 90 degree angles.
4. Ground leads should be as short as possible and go to a GOOD EARTH GROUND.
5. Interconnecting cables appearing to act as radiators or antennas should be looped through a toroid. Be certain toroids, if used, are designed for the frequency in use.

Precautions

Proper Ground

The TNC is grounded through its connections to your transceiver. Make sure your transceiver is properly grounded and your computer has equal ground potential. Follow the grounding instructions in your transceiver manual.

Lithium Battery

CAUTION: Battery can explode or leak if heated, disassembled, recharged, exposed to fire or high temperature, or inserted incorrectly.

Preface

This manual is designed to be used as a reference source for your KPC-3. If you are not familiar with connecting a Kantronics TNC to your computer and radios, we suggest that you refer to the Getting Started manual.

The first part of this manual describes all of the commands that are present in the KPC-3 and should be used mainly as a reference to find the purpose of a specific command. The commands are listed alphabetically. Following the commands section is an operational description of each mode available with your KPC-3 – Packet, Wefax, Host and Kiss modes are explained.

The final sections of this manual include information concerning the installation of your KPC-3 (which supplements the Getting Started manual), calibration and equalization, installing options into the KPC-3, and other hardware related matters.

An Introduction to Packet Radio

The KPC-3 is a Terminal Node Controller (TNC). A TNC is very similar to a telephone modem in that it receives digital signals from your computer (Terminal) and converts them to tones suitable for transmission to a distant location. The TNC also receives tones from your radio and converts them into the digital signals understood by your computer.

A TNC, however, does much more, because it also controls the push-to-talk line of your transmitter, keying the radio whenever it needs to send data. It also converts the data you want to send into a "packet", adding the required addressing, error checking and control information to insure the data gets from one Node to the next. The error checking implemented in your TNC must be the same as the error checking used by any other station you want to talk to, and this standard method is called a protocol. The protocol used in Amateur Radio Packet TNCs is called AX.25. Different protocols are used for other modes of operation, such as AMTOR.

In order for your TNC to do something, you must issue instructions to it, letting it know exactly what you want done. In order to accomplish this, the TNC must be in the Command Mode (expecting you to give it instructions) and any time you want to change the way your TNC operates, you must be in this mode. The TNC tells you that it is ready for your commands by sending you the prompt "cmd:".

When you want to send data to another station, you must place your TNC into the CONVERS mode, which allows you to converse with other users. This is normally done automatically for you when you connect to another station, or when another station connects to you.

At this point, if you are unfamiliar with packet radio operation, you may want to read the section on packet in this manual. This section is a guide to operating packet, and will help you understand the use of Command mode versus Convers mode.

Some Abbreviations

<Ctrl-x> = This represents a single control character sent from your terminal program to the TNC. To send this character, you press and HOLD the control key and type the second key (x) while holding the control key down. If your keyboard does not have a key labeled Ctrl, consult your computer/terminal manual to determine which key performs the control key function. If you don't have any key that performs this function, you will need to change the parameters in your TNC that define these special Ctrl key characters.

\$ preceding a number denotes a hex number (base 16)

<CR> = carriage return, enter, \$0D, decimal 13, <Ctrl-M>

<LF> = line feed, \$0A, decimal 10, <Ctrl-J>

I/O = Input/Output

Computer and terminal are used interchangeably to describe whatever device is attached to talk to the TNC.

Introduction to Commands

Commands Structure

There are many commands which affect operation of the KPC-3. Some commands affect performance under specific conditions, some change parameters affecting general operation and others direct a one-time action.

The user changes parameters and issues instructions to the TNC by typing commands composed of English-like word abbreviations and variables which are numbers or strings of characters chosen by the user. You will probably never change some of these parameters.

Default values are stored in the EPROM and are the settings used at power-on. If you change any setting or value, the new setting or value will be stored in RAM and will be the value used at future power-on.

● Entry

A command is entered to the TNC by typing the command name and its argument (setting or value) in the Command Mode. The prompt for Command Mode is:

cmd:

The command and argument must be separated by a space, and the TNC takes action when a carriage return <CR> is typed. All command entries may be abbreviated to the shortest unique string. In the command list which follows, those required entries are denoted by capital letters.

You can examine the value of any parameter by typing the command name followed by a <CR>. A special command, DISPLAY, allows you to see the values of all parameters or groups of related parameters.

Once you go into Packet Convers Mode or WEFAX Mode a <Ctrl-C> (see COMMAND) needs to be entered to return you to the Command Mode. In the Packet Transparent Mode a special sequence is needed (see CMDTIME).

If packets have been printing on the screen you may have forgotten which mode you are in. If you wish to see the cmd: prompt type a <Ctrl-C>, to be sure you are in Command Mode. If the prompt does not appear then you already are in Command Mode, just type a return if you wish to see the cmd: prompt.

● Format

All commands are listed alphabetically. A ☉ precedes a command from the NEWUSER set (when a unit is new, INTFACE is set to NEWUSER, or a hard reset has been performed). All other commands begin with a ●. On the first line of a command will be the command name followed by any arguments required. Any optional arguments will

be shown in square brackets []. If the command accepts several different values, or a range of values, the permissible arguments will be shown in parenthesis (). The permissible arguments may also be shown separated by a vertical bar |. At the far right of the first line will be the version number which introduced this command. The second line will show the default value. Example:

● **COM**mand arguments (permissible arguments) version
default

Parameter Types

● n (range)

Any number within the range is permissible. The unit of measure (seconds, ms, baud, count, etc.) for the number will be given in the description. These are decimal numbers.

● n (\$00 - \$FF)

Several parameters are numerical codes for characters which perform special functions. The code is simply the ASCII character code for the desired character. (See the ASCII Chart at end of this manual.) Most of these characters have control characters as default values. Control characters are entered by holding down a special control key on the keyboard while typing the indicated key. For example, to type a <Ctrl-X>, hold down the control key while typing an x, then release both keys. These special characters cannot be sent in a packet unless preceded by the pass character (see PASS) or unless you are operating in the Transparent Mode.

These numbers are shown in hexadecimal (hex) form (base 16). They can be entered either in decimal or in hex. A hex number is distinguished from a decimal number by preceding it with a "\$" prefix. The "digits" of a hex number represent powers of 16, analogous to the powers of 10 represented by a decimal number. The numbers 10 through 15 are denoted by the hex digits A through F. For example:

$$\text{\$1B} = (1*16) + 11 = 27$$

$$\text{\$120} = (1*16*16) + (2*16) + 0 = 288$$

Permissible values are shown as: (n = \$00 - \$FF). This is true if PARITY is NONE. If PARITY is not NONE, then permissible values are \$00 - \$7F. See the ASCII Chart at the end of this book for character codes and hex/decimal conversion.

If a streamswitch (STREAMSW) character or any other special character is defined as "\$" then you will need to enter values in decimal, or precede the \$ with the PASS character in order to enter hex numbers.

● flags ChoiceA|ChoiceB

Many parameters are "flags", meaning they have two possible values, ON and OFF, or YES and NO. All of the command descriptions show ON and OFF as the options; however YES (y) and NO (n) may be typed instead. A few parameters are really flags, but rather than indicating that something is "on" or "off", they select one of two ways of doing things. Some of these parameters have the values EVERY or AFTER indicating operating modes for data transmission. The possible choices are separated by a vertical bar. Some of the flag parameters will allow many choices, such as ON|OFF|TO|FROM.

● callsigns xxxxxx-n

Several commands require callsigns as parameters. While these parameters are normally Amateur callsigns, they may actually be any collection of numbers and/or letters up to six characters; they are used to identify stations sending and receiving packets. A callsign may additionally include an "extension" (SSID, Secondary Station Identifier), which is a decimal number from 0 to 15 used to distinguish two or more stations on the air with the same Amateur call (such as a base station and a repeater). The callsign and extension are entered and displayed as call-ext, e.g. KØPFX-3. If the extension is not entered, it is set to -0, and extensions of -0 are not displayed by the TNC.

● text

There are some commands which have a parameter text string. This string can be any combination of letters, numbers, punctuations, or spaces up to 128 characters. In order to be used, all string parameters must contain at least one non-space character. You can even put characters with special meanings, such as carriage return, into the string by preceding them with the PASS character. The string ends when you type a (non-passed) carriage return. If PARITY is NONE, you may even include characters in your text strings which have the eighth bit set. These are typically graphics characters on PC compatible computers.

Commands

● 8bitconv ON/OFF

v5.0

default ON

When ON, transmission of 8-bit data is allowed in the packet Convers Mode and Transparent Mode. If you wish to obtain 8-bit data transmission but do not want all the features of Transparent Mode, set this command to ON. If OFF, the 8th data bit is stripped (set to 0) for transmission. This does not affect the KA-Node, digipeat or PBBS functions.

If you are set for 8 bits and no parity, then setting this command ON will allow you to transmit any possible character, including graphics characters.

See also: parity

● ABaud n (n = 0, 300, 600, 1200, 1800, 2400, 4800, 9600)

v5.0

default 0

The parameter n sets the baud rate used for input and output through the serial port of the TNC to the computer. If 0 is used, the TNC will run an autobaud routine upon power-up. This routine looks for an asterisk (*) character from the attached computer to set the ABAUD parameter. If you wish to use a different baud rate, or to perform autobaud every time the unit is powered up, you must change the ABAUD parameter. If you change the baud rate in your computer or terminal you should change the baud rate in the TNC first, then issue the RESET command, then set the new baud rate on your computer. Otherwise a hard reset will be required to erase the ABAUD setting and reinitialize the TNC to perform the autobaud routine. (See Hard Reset section.) Note also that a hard reset will erase ALL stored parameters in your TNC and return it to factory defaults.

See also: reset, restore

● AUtoLF ON/OFF

v5.0

default ON

When ON, a line feed is sent to the terminal after each carriage return. This parameter should be set on when overprinting occurs and the terminal being used does not automatically supply its own linefeed after a carriage return. This command affects only the data sent to the terminal, not data sent to the radio.

See also: cr, lfadd

● Ax25I2v2 ON/OFF

v5.0

default ON

This command provides compatibility with all known packet units implementing AX.25 protocol. When ON, Level 2 Version 2 protocol is implemented and the TNC will automatically adapt to whichever version the connecting station is using. When OFF, Level 2 Version 1 is implemented. Set this command to OFF if you need to digipeat through other units which do not digipeat version 2 packets. You may also find benefit from setting this command OFF when using several digipeaters (not nodes) to send packets, or when conditions are marginal between the two stations involved. (NOTE: Changing this setting after connecting to another station will have no effect on the current connection.)

The major difference in V1 and V2 protocol is the method used to handle retries. In the connected mode, if a packet is sent and not acknowledged, Version 1 will resend the entire packet and then disconnect if the RETRY count is reached. Version 2 will first send a poll, the response to this poll will determine if the packet was received. It is possible that the ack was collided with and therefore the packet does not need to be resent. If the packet was not received it will be re-transmitted. Each time a poll is answered the TRIES count is reset to 0. If the RETRY count is reached, Version 2 will attempt to re-connect unless RELINK is OFF. If the re-connect attempt is unsuccessful, then Version 2 will issue a disconnect.

See also: relink, retry, tries

For more information the book *AX.25 Amateur Packet-Radio Link-Layer Protocol Version 2.0 October 1984*, can be obtained from the ARRL.

● AXDelay n (n = 0 - 255)

v5.0

default 0

Each increment specifies 10 millisecond intervals. This value specifies a period of time to wait, in addition to TXDELAY, after keying the transmitter before data is sent. This delay can be helpful when operating packet through a standard "voice" repeater, or when using an external linear amplifier which requires extra key-up time. Repeaters using slow mechanical relays, split-sites, or both require some amount of time to get RF on the air.

● **AXHang n (n = 0 - 255)**

v5.0

default 0

Each increment specifies 10 millisecond intervals. This value may be used to improve channel utilization when audio repeaters with a hang time greater than 10 msec are used. If the repeater squelch tail is long, it is not necessary to wait for AXDELAY after keying the transmitter if the repeater is still transmitting. If the TNC has heard a packet within the AXHANG period, it will not add AXDELAY to the key-up time.

● **Beacon (Every|After) n (n = 0 - 255)**

v5.0

default Every 0

Each increment specifies 1 minute intervals. A value of 0 turns the beacon OFF. Setting a value greater than 0 activates the beacon under the conditions specified. If the optional keyword Every is used, a beacon packet will be sent every n minutes. If set to After, a beacon packet will be sent ONCE after the specified interval with no channel activity.

The beacon frame consists of the text specified by BTEXT in a packet addressed to "BEACON". Beacon messages will be digipeated via any addresses specified in the UNPROTO command.

See also: btext

○ **BKondel ON|OFF**

v5.0

default ON

When ON, the sequence backspace-space-backspace is sent to the attached terminal when the DELETE character is entered. When OFF, the backslash character "\ " is sent to the terminal when the DELETE character is entered.

See also: delete, redisplay

● **BText text (0 - 128 characters)**

v5.0

default (blank)

BTEXT specifies the content of the data portion of the beacon packet. Any combination of characters and spaces may be used with a maximum length of 128. Entering a single "%" will clear BTEXT.

See also: beacon

● **BUDCalls** [+|-]callsign(s)|NONE

v5.0

default NONE

A list of up to 10 callsigns for use with BUDLIST or CONLIST. To delete or add individual entries precede the callsign with a "-" or "+" respectively. For example to delete WDØEMR type BUDC -WDØEMR.

See also: budlist, conlist

● **BUDlist** OFF(NO,NONE)|TO|FROM|BOTH(ON,YES)

v5.0

default OFF

When OFF, BUDLIST will allow monitoring of all packets even if the BUDCALLS list has callsigns in it. When BOTH or ON, only those stations whose calls are listed in the BUDCALLS will be monitored. Packets addressed to or from those callsigns will be monitored. If BUDLIST is TO, only those packets addressed to a station in the BUDCALLS list will be monitored, those from that station will not be monitored. When set to FROM, those packets from the stations in BUDCALLS will be monitored, but not those packets addressed to the BUDCALLS list. Note that suppressed calls (see SUPLIST) take precedence over BUDLIST. For instance if you have WØABC in your SUPCALLS with SUPLIST TO, and you have WØDEF in your BUDCALLS with BUDLIST BOTH, then packets from WØDEF to WØABC will NOT be monitored.

See also: budcalls, monitor, suplist

● **CALibrat**

v5.0

immediate

The CALIBRATE command is used to generate a signal which may be used as an aid in tuning the transceiver for operation with the TNC. Use of this command is explained in the Calibration/Equalization Section. The letter "X" will return you to Command Mode.

See also: Calibration/Equalization section

● **CAnline** n (n = \$00 - \$FF)

v5.0

default \$18 <Ctrl-X>

This command is used to change the cancel-line input editing command character. When in Convers or Command Mode entering a <Ctrl-X> will cancel all characters input from the keyboard back to the last un-PASSed carriage return (unless PACTIME has expired and CPACTIME is turned on).

See also: canpac, cpactime, pass

COMMANDS

July 1, 1992 Version 5.0 KPC-3

● **CANPac n** (n = \$00 - \$FF)

v5.0

default \$19 <Ctrl-Y>

This command is used to change the cancel-packet command character. When in the Convers Mode entering a <Ctrl-Y> will cancel all keyboard input back to the last unpassed SENDPAC character (unless PACTIME has expired and CPACTIME is turned on).

This character also functions as a cancel-output character in Command Mode. Typing the cancel-output character a second time re-enables normal output. For example, if you've told the TNC to do a DISPLAY, a <Ctrl-Y> will stop the display and a second one re-enables the cmd: prompt after the next <CR>.

See also: canline, cpactime, sendpac

● **CD INTERNAL|EXTERNAL|SOFTWARE**

v5.0

default INTERNAL

When set to INTERNAL, the TNC will detect a signal present on the frequency based on the method used by the attached modem. This is normally an energy type carrier detect, allowing shared voice and data on the same channel.

When set to EXTERNAL, the carrier detect is supplied by an external device, connected to the XCD pin on the radio port.

If set to SOFTWARE, the firmware inside the TNC will detect the presence of data to enable the carrier detection, allowing operation with un-squelched audio. Correct operation of SOFTWARE detect is affected by proper equalization and the SWP parameter. If your RCV light flickers, this is an indication that you may need to adjust the equalization. (Equalization is set with an internal jumper.)

See also: swp

● **CHEck n** (n = 0 - 255)

v5.0

default 0

Each increment of check is 10 seconds. If n is greater than 0, then a periodic check (poll) will be made to determine that a connected state still exists when no activity has occurred for n * 10 seconds. This prevents "hang-up" in a connected mode when a link failure occurs as a result of conditions beyond control of the connected stations. If n equals 0 then this timeout function is disabled. If using version 1 (AX25L2V2 OFF), a check timeout will initiate a disconnect.

See also: ax25l2v2, kntimer, relink, rnrtime

● **CMdtime n (n = 0 - 15)**

v5.0

default 1

Each increment specifies 1 second intervals. This command sets the time allowed for entry of required characters to escape the Transparent Mode. In order to allow escape to Command Mode from Transparent Mode, while permitting any character to be sent as data, a guard time of CMDTIME seconds is set up. After a delay of CMDTIME since the last data characters were sent to the TNC, three COMMAND characters must be entered within CMDTIME of each other. After a final delay of CMDTIME the TNC will exit Transparent Mode and enter Command Mode. At this time you should see the cmd: prompt. If CMDTIME is set to zero, the only exit from Transparent Mode is a modem break signal. Example (if CMDTIME is 1 second and COMMAND is <Ctrl-C>): wait one second, type a <Ctrl-C>, within one second type a second <Ctrl-C>, within one second type a third <Ctrl-C>, WAIT one second, cmd: prompt should appear. If your computer/program has the capability you can also send a modem break to escape Transparent Mode.

See also: command, trans

● **CMSg ON|OFF|DISC|PBBS**

v5.0

default OFF

When OFF, the custom connect text stored in CTEXT will not be sent to the connecting station upon receiving a connect request. When ON, the custom string will be sent. When CMSG is set to DISC, the custom text will be sent to the connecting station, and then your TNC will disconnect from that station. If set to PBBS, the custom text will be sent to the connecting station, and then the connection will automatically be transferred to your PBBS. This will occur if the PBBS is available. If the PBBS is not available, your TNC will disconnect from the station.

See also: ctext, pbbs

● **COMmand n (n = \$00 - \$FF)**

v5.0

default \$03 <Ctrl-C>

This command is used to change the Command Mode entry character. When COMMAND is set to the default value, typing a <Ctrl-C> causes the TNC to return to Command Mode from packet Convers Mode. (See CMDTIME for returning to Command Mode from Transparent Mode.)

● **CONList ON/OFF**

v5.0

default OFF

When ON, the TNC will recognize only those packets received with a callsign that also appears in the BUDCALLS list. All other packets are completely ignored. In other words, if a station is not in the BUDCALLS list, he may not use your station for ANY purpose, including digipeating through you. In addition, you will not be able to connect to any station that is not in your BUDCALLS list.

See also: budcalls

● **CONMode (Convers/Trans)**

v5.0

default Convers

This command controls the mode the TNC will be placed in AUTOMATICALLY after a connect if NOMODE is OFF. The connect may result either from a connect request received or a connect request originated by a CONNECT command. If the TNC is already in Convers or Transparent Mode when the connection is completed, the mode will not be changed. If you have typed part of a command line when the connection is completed, the mode change will not take place until you complete the command or cancel the line input.

See also: canline, connect, convers, nomode, trans

⊙ **Connect call1 [VIA call2, call3, ...call9]**

v5.0

immediate

call1 = callsign of station to be connected to.

call2 ... call9 = optional stations to be digipeated through. A maximum of 8 digipeater addresses (callsigns or aliases) can be specified. This is referred to as a path.

Each callsign may also have an optional Secondary Station Identifier (SSID) specified as -n, where n = 1 - 15. The digipeat callsigns are specified in the order in which they are to relay transmitted packets. The mode set by CONMODE will be entered upon successful connect, if NOMODE is OFF. If no response to the Connect request occurs after RETRY attempts, the command is aborted. A timeout message is printed on the display and the TNC remains in the Command Mode. The station being connected to (call1) may receive the connect request but be unable to accept connects, in which case a busy message will be printed to the screen and the TNC will stay in Command Mode. Connect requests may only be initiated in the Command Mode and the connect will be established on the stream you are on.

If a connect is in progress, or already established, the path may be changed by simply reissuing the CONNECT command with the desired path. This must be done on the same stream as the original connect. CAUTION, packets enroute between your station and the reconnected station may be lost.

If CONNECT is entered with no parameters, the status of the current stream is displayed.

See also: conmode, conok, maxusers, nomode, retry, ring, streamsw, xmitok

● CONOk ON/OFF

v5.0

default ON

When ON, connect requests from other TNCs will be automatically acknowledged and a <UA> packet will be sent. The standard connect message, with stream ID if appropriate, will be output to the terminal and the mode specified by CONMODE will be entered on the I/O stream if you are not connected to another station and NOMODE is OFF.

When OFF, connect requests from other TNCs will not be acknowledged and a <DM> packet will be sent to the requesting station. The message "connect request: (call)" will be output to your terminal if INTFACE is TERMINAL or NEWUSER.

When operating with multiple connects allowed, the connection will take place on the next available stream. Connect requests in excess of the number allowed by the USERS command will receive a <DM> response and the "connect request: (call)" message will be output to your terminal if INTFACE is TERMINAL or NEWUSER.

See also: conmode, connect, intface, maxusers, monitor, nomode, users

⊙ CONVers

v5.0

immediate

CONVERS has no options. It is an immediate command and will cause entry into Conversational Mode from Command Mode on the current I/O stream. Any link connections are not affected.

See also: k, command

● CPactime ON/OFF

v5.0

default OFF

When OFF and in the Convers Mode, packets are sent when the SENDPAC character is entered or when PACLEN is achieved. When ON and in the Convers Mode, packets are sent at periodic intervals determined by PACTIME. Characters are sent periodically as in Transparent Mode but the local editing and echoing features of

COMMANDS

July 1, 1992 Version 5.0 KPC-3

Convers Mode are enabled. CR should normally be OFF in this configuration, otherwise the SENDPAC character is appended at random intervals as the input is packetized by the timer.

See also: convers, cr, paclen, pactime, sendpac, trans

● **CR ON/OFF** v5.0

default ON

When ON the SENDPAC character (normally carriage return) is appended to all packets sent in Convers Mode except when PACLEN is exceeded. Setting CR ON and SENDPAC \$0D results in a natural conversation mode. Each line is sent when a <CR> is entered and arrives at its destination with the <CR> appended to the end of the line. To avoid overprinting, AUTOLF may need to be ON at the receiving end.

See also: autolf, lfadd, sendpac

● **CRSup ON/OFF** v5.0

default OFF

When ON, this command suppresses every other carriage return (when no data is between them) in the received data before sending the data to the terminal. When OFF, no suppression of data occurs.

See also: autolf, lfsup

● **CStamp ON/OFF** v5.0

default OFF

When ON, the daytime stamp is printed with all "*** CONNECTED TO" and "*** DISCONNECTED" messages on the terminal.

See also: connect, daytime, disconnect, mstamp

● **CText text (0 - 128 characters)** v5.0

default (blank)

Enter any combination of characters and spaces up to maximum length of 128. Entering a single "%" will clear CTEXT. This entry specifies the text of the first packet to be sent in response to an accepted connect request provided that the parameter CMSG is not OFF.

See also: cmsg, connect

● **CWid (Every|After) n (n = 0 - 255)**

v5.0

default Every 0

Each increment specifies 1 minute intervals. A value of 0 turns the ID OFF. Setting a value greater than 0 activates the ID under the conditions specified. If the optional keyword Every is used, an ID will be sent every n minutes. If set to After, an ID will be sent ONCE after the specified interval with no channel activity. The callsign specified by the MYCALL command will be sent in CW using AFSK tones. Some countries require all stations to ID in Morse code periodically.

See also: mycall

⊙ **DAYtime yymmddhhmmss**

v5.0

If the parameter yymmddhhmmss is present, the software clock/calendar is set for MHEARD and NDHEARD logging, and CSTAMP and MSTAMP functions. When entering the daytime digits, enter in pure number sequence with no spaces, dashes, or slashes. For example: 860102223000 would indicate 1986, January 2, at 22:30:00 hours. If DAYTIME is entered with no parameter the daytime is displayed in a form depending on the setting of the DAYUSA flag. Setting DAYTIME to 000000000000 disables the optional real time clock.

See also: cstamp, daytweak, dayusa, mheard, mstamp

● **DAYTWeak n (n = 0 - 15)**

v5.0

default 8

This parameter is used to tweak the clock for accurate time keeping. Increasing the parameter will slow the clock, decreasing the parameter will speed up the clock. Each count corresponds to .85 seconds increase or decrease per day. Ambient temperature will affect the clock to some degree.

If WEFAX pictures are skewing, use this command to adjust the clock speed of the TNC.

⊙ **DAYUsa ON|OFF**

v5.0

default ON

When ON, the daytime stamp is displayed in the form common in the USA: month/day/year. When OFF, the daytime stamp is displayed in the form common in Europe: day/month/year.

See also: daytime

● **DBldisc ON|OFF** v5.0

default OFF

When OFF, only one disconnect command (D) need be given to terminate an unsuccessful connect attempt. If you are actually connected, the normal disconnect sequence will occur. When ON, a normal disconnect sequence will always occur (you will not be disconnected until you receive an acknowledge of your disconnect or until the retry count is exceeded). A second D is required to force a local disconnect independent of the retry counter.

See also: disconnect

⊗ **DElete n (n = \$00 - \$FF)** v5.0

default \$08 <Ctrl-H>

This command sets the character to be used as the delete character. When this character is typed, the last input character is deleted. The most common settings are \$08 (backspace) and \$7F (delete).

See also: bkondel

● **DIGipeat ON|OFF** v5.0

default ON

When ON, any packet received that has MYCALL or MYNODE in the digipeat list of its address field will be retransmitted. Each station included in the digipeat list relays the packet in the order specified in the address field. Digipeating takes place concurrently with other TNC operations and does not interfere with normal connected operation of the station. To disable digipeat operations (via MYCALL or MYNODE) turn this command OFF.

See also: hid, myalias, mycall, mynode

⊗ **Disconnect** v5.0

immediate

This command will initiate an immediate disconnect request on the current I/O stream. A successful disconnect results in the display of *** DISCONNECTED. If the RETRY count is exceeded while waiting for the connected station to acknowledge, the TNC moves to the disconnected state on that stream. Entering a second Disconnect command before RETRY has expired will result in an immediate disconnect on your end, but may leave the other station thinking it is still connected to you. Disconnect messages are not displayed when the TNC is in Transparent Mode. Other commands may be entered while the disconnect is in progress.

Disconnect MYPBBS

Issue this command if you want to cause the personal mailbox to issue a disconnect to the user of the mailbox. D MYPBBS is what you should type, do not type the call entered in the mypbbs command.

Disconnect MYNODE x (x = KA-Node circuit)

x may be any of the KA-Node circuits in use, designated by A, B, C, etc. This command will cause the node to disconnect the stations linked through the node on the circuit specified. MYNODE does not refer to the call entered in the mynode command, but is the actual characters to type.

See also: dbldisc, newmode, retry, status

⊗ DISPLAY [c]

v5.0

immediate

This command causes the TNC to display a list of all the parameters in the TNC. You may also display only selected parameters by specifying the appropriate class identifier for that group. When using the DISPLAY command with a subclass be sure to use a space between the DISPLAY command and the subclass. Subclasses of related parameters are:

(A)sync	asynchronous port parameters (TNC to computer)
(C)haracter	special TNC characters
(I)d	ID parameters
(L)ink	parameters affecting packet link (TNC to TNC)
(M)onitor	monitor parameters
(P)pbs	mailbox commands
(T)iming	timing parameters

Individual parameter values can be displayed by entering the command name followed by <CR>.

See also: Display Listings section

⊙ DWait n (n = 0 - 255)

v5.0

default 0

Each increment specifies 10 ms intervals. This value is used to avoid collisions with digipeated packets. The TNC will wait $n * 10$ ms after last hearing data on the channel before it begins its own key-up sequence. This value should be established and agreed on by all members of a local area network. The best value will be determined by experimentation but will be a function of the key-up time (TXDELAY). This feature is made available to help alleviate the drastic reduction of throughput which occurs on a channel when digipeated packets suffer collisions. Digipeated packets are not retried by the digipeater but must be restarted by the originating station. If all stations specify DWAIT, and the right value is chosen, the digipeater will capture the frequency every time it has data to send since digipeated packets are sent without this delay.

Observations have proven that a better algorithm for avoiding collisions between end-user stations, while still allowing digipeaters the high-priority access they require is achieved using persistence and slottime to determine proper transmit intervals, and setting DWAIT to 0.

See also: persist, slottime

⊙ Echo ON|OFF

v5.0

default ON

When ON, characters received from the computer by the TNC are echoed back and displayed. If you are receiving double print of characters entered at the keyboard, turn this command OFF. This corresponds to the setting in your terminal program for duplex. If your program is set for full-duplex set ECHO ON. If your program is set for half-duplex (some call it echo) then set ECHO in the TNC to OFF. Regardless of the setting of this command, the TNC will not echo an X-OFF or X-ON character to the terminal when it receives a STOP or START character. Echo is disabled in Transparent Mode.

See also: bkondel, flow

● EEscape ON|OFF

v5.0

default OFF

This command specifies the character which will be output to the terminal when an escape character (\$1B) is received in a packet. When OFF, \$1B is sent, this is useful if your terminal interprets ESC characters as screen positioning commands (ANSI). When ON, the escape character is sent as a dollar sign (\$).

● **Filter ON/OFF**

v5.0

default OFF

When ON, this command will inhibit the printing of control characters (hex \$00 - \$19) which may be present in monitored packets. This will be useful if you are monitoring channel traffic which includes binary file transfers or higher level protocols (networks talking to each other). Control characters which may be embedded in those packets can have strange and unpredictable effects on the monitoring TNC. All control characters except carriage return (\$0D) and line feed (\$0A) will be filtered. This command DOES NOT affect receipt of control characters in packets received from a "connected" station when MONITOR or MCON is OFF.

See also: monitor

● **Flow ON/OFF**

v5.0

default ON

When FLOW is ON, any character entered from the terminal will halt output to the terminal until the current packet is completed (by SENDPAC, PACLEN, or PACTIME). Cancelling the current input to the TNC or typing the REDISPLAY-line character will also cause output to resume. FLOW will keep received data from interfering with data entry. When FLOW is OFF, received data will be "inter-leaved" with keyboard entry. If using a split screen terminal program, you should have FLOW OFF and ECHO OFF to allow received data to be displayed while you type into the TNC's type-ahead buffer.

See also: canline, canpac, cpactime, echo, paclen, redisplay, sendpac

● **FRack n (n = 1 - 15)**

v5.0

default 4

Each increment specifies 1 second intervals. After transmitting a packet requiring acknowledgment, the TNC waits FRACK seconds before incrementing the retry counter and sending the packet again. If the retry count (specified by the RETRY command) is exceeded, the current operation is aborted. If the packet address includes digipeaters, the time between retries is adjusted to $FRACK * ((2 * m) + 1)$ where m is the number of digipeater stations specified. When the retried packet is sent, a random wait time is also added to avoid lockups where two units repeatedly collide with each other.

The FRACK timer begins when PTT is released (the packet has been sent) and is suspended when data carrier from the radio is present, or when your station is transmitting.

See also: connect, resptime, retry

● **FULLdup ON|OFF**

v5.0

default OFF

When OFF, the data carrier detect signal is used as a packet collision avoidance signal. When ON, the modem is run full duplex, and carrier detect does not inhibit transmission. The full duplex mode may be useful especially for satellite operations using duplex radio setups. Full duplex should not be used unless both you and the station you are communicating with have full duplex capability.

● **HBAud n (n = 300, 400, 600, or 1200)**

v5.0

default 1200

This baud rate specifies the rate of data exchange between the radio stations. The value of HBAUD has NO relationship to the terminal baud rate specified with ABAUD. In order to communicate with other packet stations, the baud rate must be the same at each end of the link. As a general rule, 300 baud is used on frequencies below 28 MHz, 1200 baud is used on frequencies above 28 MHz. FCC rules currently limit the maximum baud rate to 300 when operating below 28 MHz. Although the KPC-3 can operate 300 baud, the modem tones will still use a 1000 Hz shift whereas most HF packet uses a 200 Hz shift.

● **HEAderln ON|OFF**

v5.0

default ON

When ON a carriage return is output to the terminal between the header and text of monitored packets. This causes the packet header and time stamp (if on) to be displayed on one line, with the packet text displayed below it on the next line. When receiving only packets addressed to you (MONITOR and/or MCON OFF) this parameter does not apply. When OFF the data will be on the same line as the header.

See also: cstamp, mcon, monitor, mstamp

⊗ **Help [command]**

v5.0

immediate

This command, when entered without any arguments, will display a list of all of the commands available in the KPC-3. If an optional command is given, a brief description of the stated command is displayed. NOTE: If you give the Help Help command using a Host mode program, you may experience a *very* long delay before the data appears on your screen.

● **HIId ON/OFF**

v5.0

default ON

When ON, an ID packet will be sent every 9.5 minutes, provided that packets are being digipeated through your station, or routed through your KA-Node, or into your PBBS. This command should be ON if digipeating, node or pbbs is enabled. If OFF, periodic identification packets will not be sent.

See also: digipeat, id, myalias, mynode, mypbbs, numnodes, pbbs

● **Id**

v5.0

immediate

When this command is entered an identification packet will be forced. This command can be used to insure that your station identification is the last transmission before taking the station off the air. The ID packet is an unnumbered information <UI> packet whose data consists of your station identification as set in MYCALL. The MYCALL will be appended with "/R", MYALIAS callsign appended with "/D", MYNODE callsign appended with "/N", and MYPBBS callsign appended with "/B", if these functions are enabled. This packet will be addressed to "ID" and digipeated via any addresses specified in the UNPROTO command.

See also: hid, unproto

⊙ **INtface NEWUSER|TERMINAL|BBS|HOST|KISS**

v5.0

default NEWUSER

When set to NEWUSER, the TNC will operate with a standard terminal or computer running a terminal emulation program with a limited command set available. When set to TERMINAL, the full command set of the TNC is available. When set to BBS, the TNC deletes certain messages (i.e. *** connect request, *** FRMR, etc) for greater compatibility with full-service BBS programs such as WØRLI, WA7MBL, CBBS, etc. When set to HOST, the TNC will talk to the attached computer using the Kantronics HOST mode. (See the Host Mode Section for details.) When set to KISS, the KISS code as specified by Phil Karn is implemented for communication to the attached computer. (See the KISS Mode section.)

After changing the setting of this command, a soft reset must be performed for the new mode to take effect (see RESET).

- ⊙ K** **v5.0**
 immediate
 This single letter command is synonymous with **CONVERS**. It is included as a single-keystroke convenience for entering Convers Mode.
 See also: **convers**
- Kntimer n (n = 0 - 255)** **v5.0**
 default 15
 If there is no activity (data) on a KA-Node circuit for n minutes, the KA-Node will disconnect both the input and output sides of the KA-Node circuit. Setting **KNTIMER** to 0 disables this feature.
 See also: **rrrtime**
- LCok ON|OFF** **v5.0**
 default ON
 When ON, no character translation occurs in the TNC. If OFF, lower case characters will be translated to upper case before being output to the terminal from the TNC. This case translation is disabled in Packet Transparent Mode.
- LCStream ON|OFF** **v5.0**
 default ON
 When ON, the TNC allows for lower-case characters to be used in stream switching.
 See also: **status, streamsw**
- Leds ON|OFF** **v5.0**
 default ON
 When OFF the software controlled front panel LEDs will not light, in order to conserve power.
- LFadd ON|OFF** **v5.0**
 default OFF
 When ON, a line-feed will be appended to every carriage return received from the keyboard before being transmitted. When OFF, no line feeds will be added to the transmitted signal.

● **LFSup ON|OFF** v5.0

default OFF

When ON, this command suppresses any line-feed characters received from the other station, relying on your terminal program to properly advance to the next line. When OFF, the line-feeds received from the other station are not suppressed but are sent to your terminal as received.

See also: autolf, crsup

● **LList ON|OFF** v5.0

default OFF

When ON, stations in the SUPCALLS list attempting to connect to or digipeat through your station will be ignored.

See also: supcalls

● **MAIL ON|OFF** v5.0

default ON

When ON, monitored packets include "connected" packets between other stations. If OFF, other station's connected packets will not be monitored. This is a useful arrangement when stations are talking as a group in an unconnected configuration.

See also: monitor

● **MAXframe n (n = 1 - 7)** v5.0

default 4

MAXFRAME sets an upper limit on the number of unacknowledged packets which can be outstanding at any one time. The TNC will send MAXFRAME number of packets in a single transmission, if they are available.

See also: paclen

● **MAXUsers n (n = 1 - 26)** v5.0

default 10

This command causes the TNC to allocate the memory required for the maximum number of simultaneous connections you wish to allow. Each connection uses a different stream. In order to direct what you want to say to a different stream you use the STREAMSW character. All streams may be used for outgoing packets, but USERS sets the number that may be used for incoming connections. Changing the value of

COMMANDS

July 1, 1992 Version 5.0 KPC-3

MAXUSERS will cause the TNC to perform a "soft reset". In order to change the current value of MAXUSERS, you must spell out the entire command word. Note that you may not change the value of MAXUSERS while you are connected, since this would reset the TNC and cause all existing connections to be lost.

See also: status, streamsw, users

● MBeacon ON/OFF v5.0

default ON

This command determines whether packets addressed to Beacon or ID will be monitored and displayed on the screen. If you do not wish to monitor Beacon or ID packets, turn this command OFF.

See also: beacon, id, monitor

● MCOM ON/OFF v5.0

default OFF

When ON, monitored packets include the following AX.25 control packets, if MONITOR is ON. If connected, MCON must also be ON. The "<" and "<<" characters are used to bracket and denote packets received as version 1 or version 2, respectively. The bracketed information will appear at the end of the header information.

- <C> Connect request
- <D> Disconnect request
- <DM> Disconnected Mode
- <UA> Unnumbered Acknowledge

In addition, the following bracketed information will be added to the Information packets as appropriate:

- <UI> Unconnected Information frame
- <Is> Information frame (connected); s = send sequence number

See also: ax25l2v2, monitor, mresp

For more information, the book *AX.25 Amateur Packet-Radio Link-Layer Protocol Version 2.0 October 1984*, can be obtained from the ARRL.

● **MCon ON/OFF**

v5.0

default OFF

When OFF, and connected, you will monitor only those packets addressed to you. Any header information displayed will be determined by the settings of **STREAMEV** and **STREAMCA**. When OFF, and not connected, all eligible packets (as determined by other monitor commands) will be monitored. When ON, all eligible packets will be monitored whether connected or unconnected.

See also: monitor, streamca, streamev

● **MHClear**

v5.0

immediate

This command erases the stations heard log.

See also: mheard

⊙ **MHeard [S|L]**

v5.0

immediate

This command causes display of a list of stations heard. An asterisk, *, indicates that the station was heard through a digipeater. The date/time the station was last heard is also displayed. If the S option is used, i.e. **MHEARD S**, then only the callsigns of the stations heard will be displayed. If the L option is selected, all callsigns contained in the received packet as well as the digipeater paths, are displayed. For example:

```
WDØEMR > ID    10/16/88 14:31:30
  VIA TOP, KSBRE, WØXI, SUTNE
```

Here, your station heard **WDØEMR** transmitting an ID packet. **WDØEMR** was also using the digipeating path **TOP, KSBRE, WØXI, SUTNE**. If your station heard **WDØEMR** via one of these other stations, an asterisk would show by the call or alias of the last digipeater heard and an asterisk would show beside **WDØEMR**.

See also: daytime, mhclear

⊙ **Monitor ON/OFF**

v5.0

default ON

When ON, unconnected packets will be monitored unless prohibited by **SUPLIST**, **BUDLIST**, **CONLIST**, or **LLIST**. This will also allow monitoring of other packets if permitted by the other monitor commands. The **MONITOR** command acts as a master switch for the **MALL**, **MCOM**, **MCON**, **MRESP**, and **MRPT** commands. The addresses in the packet are displayed along with the data portion of the packet. Callsigns (to and from fields) are separated by a ">"; and the Secondary Station Identifier (SSID) is

COMMANDS

July 1, 1992 · Version 5.0 · KPC-3

displayed if it is other than 0. If any data is contained in the monitored packet which is not described in the AX.25 protocol, it is displayed in curly braces on the header line. All monitor functions are disabled in the Transparent Mode.

When OFF, you will monitor only those stations connected to you, no matter how other monitor commands are set. Any header information displayed will be determined by the settings of STREAMCA and STREAMEV.

See also: budlist, conlist, headerln, llist, mall, mbeacon, mcom, mcon, mresp, mrpt, mstamp, pid, streamca, streamev, suplist

● MRcsp ON/OFF

v5.0

default OFF

When ON, monitored packets include the following AX.25 response packets, if MONITOR and MCOM are ON. If connected, MCON must also be on. The bracketed information will appear at the end of the header information. The "<" and "<<" characters are used to bracket and denote packets received as version 1 or version 2, respectively. For example, "<<RR1>>" denotes a version 2 packet. In addition upper case characters are used to designate commands (polls) and lower case characters are used to denote responses for RR, REJ, and RNR. For example, <<rr1>> is a response in version 2.

- <FRMR> Frame Reject
- <REJr> Reject, r = received sequence number
- <RNRr> Device busy, r = received sequence number
- <RRr> Receive Ready, r = received sequence number

In addition, the following bracketed information will be added to the Information packets as appropriate:

- <Isr> Information frame (connected);
s = send sequence number, r = received sequence number

See also: ax25l2v2, mcom, monitor

For more information the book *AX.25 Amateur Packet-Radio Link-Layer Protocol Version 2.0 October 1984*, can be obtained from the ARRL.

● **MRPt ON/OFF**

v5.0

default ON

This command affects the way monitored packets are displayed. If ON, the entire digipeat list is displayed for monitored packets, and the station that relayed the packet is indicated with an asterisk. The MONITOR command must be ON for this command to work, and if connected MCON must also be ON. If OFF, only the originating station and the destination station callsigns are displayed for monitored packets.

See also: monitor

● **MStamp ON/OFF**

v5.0

default OFF

This command enables time stamping of monitored packets. The date and time information is then available for use for automatic logging of packet activity or other computer applications. The date and time are set initially by the DAYTIME command, and the date format is determined by the DAYUSA command. The MONITOR command must be ON for this command to work, and if connected MCON must also be ON.

See also: cstamp, daytime, monitor

● **MYAlias xxxxxx-n**

v5.0

default (blank)

Setting this command to a callsign or character string enables digipeating by using the MYALIAS. Enter up to six characters (plus optional SSID) which are different than those used for MYCALL, MYNODE, MYPBBS, or MYREMOTE. For example: you may enter LAW-3 as the MYALIAS, which would be easier to remember for stations wishing to digipeat through a station in Lawrence, enroute to a station more distant. You may disable the alias digipeating with the command MYALIAS %.

See also: hid

⊙ **MYcall xxxxxx-n**

v5.0

This command tells the TNC what its callsign is. When the TNC is first turned on out of the box, or after a hard reset, it asks you for your callsign – there is NO DEFAULT. The callsign you enter is placed in this parameter. The extension n is called a Secondary Station Identifier (SSID) and is defaulted as 0, but may be any number from 0 to 15. All packets originated by the TNC will contain this callsign in the FROM

address field. Any packets received by the TNC with this callsign in the TO address field or digipeat fields will be responded to appropriately (connect, disconnect, ack, digipeat, etc.).

See also: cwid, digipeat, id, myalias, mynode, mypbbs, myremote

● **MYNode xxxxxx-n** v5.0

default MYCALL-7

Setting this command to a callsign or character string enables the KA-Node in the TNC. Enter up to six characters (plus optional SSID) which are different than those used for MYCALL, MYALIAS, MYPBBS, or MYREMOTE. You must also have the NUMNODES command set to a non-zero value. You may disable the KA-Node by setting MYNODE to the same as MYCALL, or setting NUMNODES 0.

See also: digipeat, ndwild, numnodes; KA-Node section

⊙ **MYPbbs xxxxxx-n** v5.0

default MYCALL-1

Enter up to six characters which will be used as the operating address for your Personal Packet Mailbox. Enter up to six characters (plus optional SSID) which are different than those used for MYCALL, MYALIAS, MYNODE, or MYREMOTE.

See also: pbbs

● **MYRemote xxxxxx-n** v5.0

default (blank)

This command sets the callsign used for remote access to the command set of the TNC. Enter up to six characters (plus optional SSID) which are different than those used for MYCALL, MYALIAS, MYNODE, or MYPBBS. In addition, the RTEXT must be programmed with a text string. A station that connects will be sent a series of numbers that must be decoded according to RTEXT.

See also: rtext; Remote Access section

● **NDHClear** v5.0

immediate

This command will clear the list of nodes heard by the TNC.

See also: ndheard

● **NDHeard [S|L]**

v5.0

immediate

This command allows the operator to display a list of nodes whose ID packets have been heard by the TNC. The lists includes KA-Nodes as well as TheNet, NET/ROM and G8BPQ nodes. TheNet, NET/ROM and G8BPQ nodes are identified as:

ALIAS (CALLSIGN)

and Kantronics KA-Nodes will be identified as:

MYNODE (MYCALL)

An asterisk, *, indicates that the station was heard through a digipeater. The date/time the station was last heard is also displayed. If the S option is used, i.e. NDHEARD S, then only the callsigns of the stations heard will be displayed. If the L option is selected, all callsigns contained in the received packet are displayed. (See MHEARD for display.)

See also: mynode, ndhclear

● **NDWild ON|OFF**

v5.0

default OFF

When OFF, the KA-Node will only recognize connect requests directed to the MYNODE call. When ON, connect requests to any SSID of the MYNODE call will be recognized as connects to the KA-Node, if that SSID is not being used for any other ID in the TNC.

See also: myalias, mycall, mynode, mypbbs, myremote

● **NEwmode ON|OFF**

v5.0

default ON

When ON, the TNC will return to Command Mode if the station on the current I/O stream disconnects. The TNC will not return to Command Mode if the station disconnecting is on a different stream. When OFF, a disconnect will not cause the TNC to change modes.

See also: connect, disconnect, status

● **NOmode ON/OFF** **v5.0**

default OFF

When OFF and a connection takes place, the TNC will change to whatever mode is specified in CONMODE. When ON, the TNC stays in Command Mode after connecting to another station; that is, it does not immediately change to Convers or Transparent Mode.

See also: conmode, connect

● **NText message (up to 128 characters)** **v5.0**

default (blank)

This entry specifies customized text to be sent with the initial KA-Node sign-on message (when the KA-Node is connected to by a remote station). Enter any combination of characters and spaces up to a maximum length of 128. Entering a single "%" will clear NTEXT.

See also: mynode, numnodes

● **NUcr n (n = 0 - 31)** **v5.0**

default 0

This command determines the number of nulls sent to the terminal after a <CR>, in order to enable a transmission delay following any <CR> sent to the terminal. This is useful for some hardcopy terminals.

● **NULf n (n = 0 - 31)** **v5.0**

default 0

This command determines the number of nulls sent to the terminal after a <LF>, in order to enable a transmission delay following any <LF> sent to the terminal. This is useful for some hardcopy terminals.

● **NUMnodes n (n = 0 - 6)** **v5.0**

default 0

This command is used to set the number of allowable circuits through the KA-Node. For example, if you wish to allow up to 3 simultaneous circuits through the node, set NUMNODES 3. This command will cause a soft reset.

Approximately 4K of RAM is used for each circuit. The amount of RAM available will depend on how much RAM has been used for the PBBS, MAXUSERS, and MYREMOTE parameters. If you select n larger than available RAM will allow, a "Not

enough RAM" message will be returned to you. Generally, set the amount of RAM required first for your PBBS (personal bulletin board) and then set the desired number of circuits. If n is set to 6 you can not have a mailbox. If n is larger than 6, a "Value out of range" message will be returned to you.

See also: mynode; KA-Node section

● **Paclen n (n = 0 - 255)** v5.0

default 128

This command specifies the maximum length of the data portion of a packet. The TNC will automatically send a packet when the number of input bytes reaches n. This value is used in both Convers and Transparent Modes. A value of 0 means 256 bytes.

See also: maxframe

● **PACTime (Every|After) n (n = 0 - 255)** v5.0

default After 10

This parameter is always used in Transparent Mode, and will also be used in Convers Mode if CPACTIME is ON. When After is specified, bytes are packaged when input from the terminal stops for n*100 ms or when PACLEN is reached. When Every is specified, input bytes are packaged and queued for transmission every n * 100 ms or when PACLEN is reached. A zero length packet is never produced, and the timer is not started until a new byte is entered. If Every or After is not given, the current state is retained.

See also: cpactime, trans

● **PARity NONE|EVEN|ODD|MARK|SPACE** v5.0

default NONE or EVEN (determined by autobaud routine)

This command sets the Parity mode for communication with the terminal.

The autobaud routine sets PARITY based on what is received when the * is pressed. If the 8th bit is set, PARITY is set EVEN. If the 8th bit is not set, PARITY is set to NONE. This command corresponds to the setting of parity in your communications program. The TNC can only send serial output with 8 data bits and one stop bit. Setting the PARITY parameter defines the eighth bit.

When transmitting in Packet Mode, the 8th bit is stripped (i.e. set to 0) if PARITY is set to EVEN, ODD, MARK, or SPACE. If PARITY is set to NONE, all 8 bits from the computer may be transmitted if the 8BITCONV command is ON.

See also: 8bitconv

● **PASs n** (n = \$00 - \$FF)

v5.0

default \$16 <Ctrl-V>

This command selects the ASCII character used for the pass input editing command. You may use this character to send any character in a packet in Convers Mode, even though that character may have a special function. For example, if you wish to send a COMMAND character (<Ctrl-C>) as part of the packet, you can do so by preceding it with the PASS character. The character will be sent rather than returning the TNC to Command Mode. In Transparent Mode all characters are passed, there are no special functions except the one combination to get out of transparent.

● **PASSALL ON/OFF**

v5.0

default OFF

When OFF, packets will only be displayed if the CRC (error checking) is correct, and according to monitor commands. When this command is ON, the TNC will accept packets, regardless of whether or not the CRC is correct. The TNC will attempt to decode the address field as well as the data field and display the packets as specified by other commands such as MONITOR. The entire packet, determined by the beginning and ending flags, must be received before an attempt is made to decode. If both flags are not received the data will not be decoded. MHEARD and NDHEARD logging are disabled when PASSALL is ON.

○ **PBbs n** (maximum depends on RAM)

v5.0

default 5

Setting n greater than 0 allocates memory and activates the Personal Mailbox in the TNC. The amount of memory allocated will be n kilobytes, and may be limited by other functions requiring memory (e.g. NUMNODES and MAXUSERS). Changing the size of the PBBS memory allocation will not affect the contents of the mailbox (messages will be preserved). If you attempt to set the PBBS smaller than is required for existing messages you will receive the message "Messages would be lost" and no change will be made to the mailbox size. In this case to reduce the size of the mailbox you must first either kill some of the messages or set PBBS 0 which will delete all messages; then set the new size. Using the PBBS n command with n equal to the current size will renumber the messages in the mailbox beginning with message number 1. If n is a different size, the messages will not be renumbered. This command causes a soft reset if n is different from its previous value.

If NUMNODES is set to 6, you can not have a mailbox.

See also: msg, mypbbs, pbheader, pblo, pbperson, ptext; PBBS section

● **PBHeader ON|OFF**

v5.0

default ON

When ON the routing headers received from a full service BBS will be stored in the PBBS mailbox. When OFF, these headers are not stored in the mailbox, allowing messages to require considerably less space. The routing headers are those lines you normally see in messages beginning with R. Note that the PBBS will ignore all lines beginning with R: until it sees the first line that does not have R: in column one. From that point on, all of the message will be stored, even if a line begins with an R:

See also: PBBS section

● **PBL_o [OLD|NEW] [FIXED|VARIABLE]**

v5.0

default OLD FIXED

When set to OLD the PBBS will list messages to the user from oldest to newest (i.e. ascending numerical order). When set to NEW, the newest message will be listed first. When the second parameter is set to FIXED, the user cannot change the listing order. When the second parameter is set to VARIABLE, the user may change the order in which messages will be listed by using the LO command within the PBBS.

See also: PBBS section

● **PBPerson ON|OFF**

v5.0

default OFF

When OFF the personal mailbox will allow messages to be sent to any callsign. When ON only messages addressed to the MYCALL or MYPBBS callsigns will be accepted over the radio, but a message entered from the terminal may be addressed to anyone.

See also: mycall, mypbbs, pbbs

● **PERsist n (n = 0 - 255)**

v5.0

default 63

n is used to determine if a packet will be sent after SLOTTIME expires. For example, let's assume a PERSIST setting of 63 and a SLOTTIME setting of 10. This slottime setting corresponds to 100 milliseconds. When the TNC detects that the channel is clear and available (no carrier is detected), it starts a timer (SLOTTIME). When the timer expires (100 ms in our case) the TNC generates a random number between 0 and 255. If the generated number is equal to or less than the PERSIST value, the TNC keys up the transmitter and sends the data packet. With our setting of 63 the odds of this occurring after the first slottime are 1 in 4. (Actually the probability is PERSIST plus 1 divided by 256.) If the TNC generated random number is greater

than PERSIST, the TNC restarts the timer and waits for the timer to expire again before generating a new random number. This is repeated until the TNC gains channel access and sends its packet of information.

The algorithm used to determine whether or not to transmit using the PERSIST/SLOTTIME method has been shown to be considerably more sophisticated than the DWAIT method used by most standard AX.25 packet stations. The result of using the persistence algorithm is increased throughput under most channel conditions. Making SLOTTIME smaller will cause the TNC to generate the random number more frequently, whereas raising the PERSIST value will give a better chance (improve the odds) of transmitting the data. Through careful choice of these values, it is possible to improve data throughput while at the same time permitting shared channel usage by other packet stations. The persistence algorithm has been added on top of the DWAIT algorithm.

See also: slottime

● **PId ON|OFF**

v5.0

default OFF

When OFF only those packets with a protocol ID of \$F0 (pure AX.25) are displayed. When ON all packets are displayed. Some of the information in non-AX.25 (for example: TCP/IP, NET/ROM or TheNet) packets can cause some computers to lock up. The header will also show the PID in curly braces, i.e., (CF). For information, Net/Rom, TheNet and G8BPQ type nodes have a PID of CF, TCP/IP uses CC and CD, and standard AX.25 is F0.

● **PText message (up to 128 characters)**

v5.0

default (blank)

This entry specifies the customized text sent with the initial PBBS (personal mailbox) sign-on message (when the PBBS is connected to by a remote station). Enter any combination of characters and spaces up to a maximum length of 128. Entering a single "%" will clear PTEXT. You should not have the ">" character in your PTEXT, as this is reserved by BBS systems for their prompt.

See also: pbbs

● **Redisplay n (n = \$00 - \$FF)**

v5.0

default \$12 <Ctrl-R>

This command is used to change the REDISPLAY-packet input editing character. The parameter n is the ASCII code for the character you want to type in order to REDISPLAY the packet currently being entered.

You can type this character to cause the TNC to redisplay the packet you have begun. When you type the REDISPLAY-packet character, the following things happen: First, type-in flow control is released (if FLOW was enabled). This displays any incoming packets that are pending. Then a \ (backslash) character is displayed, and the packet you have begun is redisplayed on the next line. If you have deleted and retyped any character, only the final form of the packet will be shown. You are now ready to continue typing where you left off. Incoming packets will continue to be displayed until you type the next character to be inserted into the packet.

You can use the REDISPLAY-packet character to see a "clean" copy of your input if you are using a printing terminal (or have BKONDEL OFF) and you have deleted characters. The REDISPLAYed packet will show the corrected text.

You can also use this character if you are typing a message in Convers Mode and a packet comes in. You can see the incoming message before you send your packet, without cancelling your input.

See also: bkondel, canline, canpac, flow

● RELink ON|OFF

v5.0

default OFF

When OFF, the TNC operating with AX25L2V2 ON does not attempt to automatically reconnect. When ON, the TNC operating with AX25L2V2 ON will attempt to automatically reconnect after RETRY is exceeded.

The KA-Node and the PBBS will never attempt to reconnect regardless of the setting of this command. If using AX.25 Level 2 Version 1 (AX25L2V2 OFF) this command has no effect.

See also: ax25l2v2, retry, tries

○ RESET

v5.0

immediate

This command is used to perform a soft reset. What is in the mailbox (PBBS) is kept, and the NDHEARD and MHEARD logs are not cleared. Any existing connections will not be recognized by your TNC even though the other end still believes it is connected to you. The initial sign-on message will be displayed.

See also: intface, maxusers, myremote, numnodes, pbbs, restore

● **RESPtime n (n = 0 - 255)**

v5.0

default 5

The number specified establishes a minimum delay, in 100 ms increments, that is imposed on acknowledgment of information-bearing packets (I-frames). Delay may run concurrently with DWAIT (PERSIST and SLOTTIME) and any other random delays in effect. This command is useful in avoiding collisions during such activity as file transfers using full-length packets. This timer is suspended whenever PTT or carrier detect is present if operating half-duplex.

See also: frack

● **RESTORE Default**

v5.0

immediate

When RESTORE D is given, the TNC will revert to factory default settings, ask for your callsign, and then perform a soft reset. The ABAUD parameter will be set to 0 but the unit will not perform the autobaud routine until the next time it is turned off and on.

See also: reset

● **RETry n (n = 0 - 15)**

v5.0

default 10

This command specifies the number of packet retries. Packets are re-transmitted n times before the operation is aborted. The time between retries is specified by the command FRACK.

See also: ax25l2v2, frack, relink, tries

● **RIng ON|OFF**

v5.0

default ON

When ON, three bell characters (\$07) are sent to the terminal with each "**** CONNECTED TO" message when another station initiates the connect.

● **RNrtime n (n = 0 - 255)**

v5.0

default 0

RNRTIME is set in 10 second increments. If a connection stays in a remote device busy state (continues to receive RNR frames) for RNRTIME, the TNC will disconnect. If a KA-Node connection stays in a remote device busy for RNRTIME the KA-Node will disconnect the input and output sides of the KA-Node circuit. Setting RNRTIME to 0 disables this function.

See also: mresp

● **RText text (up to 128 characters)**

v5.0

default (blank)

This command sets the password string for use when accessing the MYREMOTE or when performing SYSOP functions in the PBBS remotely. When you connect to the MYREMOTE or attempt to enter the SYSOP mode of the PBBS, the TNC will send three sets of numbers, one of which must be properly decoded using this string. For instance, if the RTEXT is set to "This is my RTEXT string" and you connect to the MYREMOTE, the TNC would send three sets of random numbers. The numbers would look like:

```
5 20 14 7 18 3
7 1 4 14 8 19
9 3 8 12 22 1
```

You must then pick ONE of these lines and decode the password string. Let's say I choose to decode line 3 (9 3 8 12 22 1). Rewriting my RTEXT string to make this easier I would have:

```
          1          2
12345678901234567890123
This is my RTEXT string
```

Now, decoding the string, character 9 is "m" character 3 is "i", character 8 is " ", character 12 is "R", character 22 is "n", and character 1 is "T". I must send the following in response to my remote access attempt:

```
mi RnT
```

Note that case is significant and spaces are considered valid characters. If you fail to properly decode the password, the TNC will send three new lines of numbers. You will be given a maximum of three attempts to properly decode the password string. If you fail in three attempts, the TNC will disconnect you. After failing in three attempts, the MYREMOTE is disabled for 15 minutes.

● **S**creenl n (n = 0 - 255) v5.0

default 0

This value is used to properly format what is sent to your terminal. A <CR> sequence is sent to the terminal at the end of a line when n characters have been printed. A value of zero inhibits this action.

See also: autolf

● **S**endpac n (n = \$00 - \$FF) v5.0

default \$0D <Ctrl-M>

This command specifies a character that will force a packet to be sent in Convers Mode. In the Convers Mode, packets are sent when the SENDPAC character is entered or when PACLEN is achieved.

See also: cpactime, cr

● **S**Lottime n (n = 0 - 255) v5.0

default 10

n specifies the amount of time, in 10 millisecond increments, between successive tries of the persistence algorithm.

See also: persist

● **S**TARt n (n = \$00 - \$FF) v5.0

default \$11 <Ctrl-Q>

This command specifies the character sent by the computer to the TNC to restart input from the TNC. If set to \$00 only hardware flow control will be used. For software flow control, set this parameter to the character the computer will send to restart data flow.

See also: stop, xflow, xoff, xon

● **S**TATShrt ON|OFF v5.0

default ON

If ON, entry of the STATUS command will display only the current I/O stream and any other streams having a connected status. If OFF, entry of the STATUS command will display all streams allowed by MAXUSERS, PBBS, NUMNODES, and MYREMOTE.

See also: status

⊙ Status

v5.0

immediate

This command will display both the identifier and link state of all allowed streams. If STATSHRT is ON only active streams will be displayed. The current input and output (IO) stream is also indicated. A pound sign (#) indicates that there is unacknowledged data in the buffers for that stream. The number immediately following the # is the number of bytes outstanding. The number in parentheses is the number of packets not yet acknowledged.

The following is an example of a display (with STATSHRT OFF). A, B, C, through J indicate the stream. "A" stream is connected to KEØSM and has 50 bytes in 2 packets that are unacknowledged. The current stream (IO) is the "B" stream, which is connected to WK5M. KA5ZTX is connected on circuit "A" of the KA-Node. All other streams, node circuits, the BBS, and the remote access are disconnected.

```
cmd:status
FREE BYTES 1661
A stream -      #50(2) CONNECTED to KEØSM
B stream - IO   CONNECTED to WK5M
C stream -      DISCONNECTED
.....
.....
J stream -      DISCONNECTED
BBS DISCONNECTED
REM DISCONNECTED
Ain  CONNECTED to KA5ZTX
Aout DISCONNECTED
Bin  DISCONNECTED
Bout DISCONNECTED
```

See also: maxusers, myremote, numnodes, pbbs, statshrt, streamsw

● STOp n (n = \$00 - \$FF)

v5.0

default \$13 <Ctrl-S>

This command specifies the character sent by the computer to the TNC to stop input from the TNC. If set to \$00 only hardware flow control will be used. For software flow control set this parameter to the character the computer will send to stop data flow.

See also: start, xflow, xoff, xon

● **STREAMCa ON/OFF**

v5.0

default OFF

When receiving packets addressed only to you, setting this command ON will enable the display of the callsign of the connected-to station following the stream identifier of the connection (controlled by STREAMEV). This is especially useful when operating with multiple connections allowed.

See also: mcon, monitor, streamev

● **STREAMEv ON/OFF**

v5.0

default OFF

When OFF, the stream indicator is displayed only when a change in streams occurs. When ON, the stream indicator will be displayed with every incoming packet. This command takes effect when receiving only those packets addressed to you.

See also: mcon, monitor, streamca, streamsw

● **STReamsw n (n = \$00 - \$FF)**

v5.0

default \$7C (I)

This command selects the character to be used to signify that a new "stream" or connection channel is being addressed. To change streams you must type the streamswitch character followed immediately by the stream designator. The stream designator is an alphabetic character A through Z limited by the value of MAXUSERS.

If STREAMSW is set to a dollar sign (\$24) you will need to enter numerical code type parameter values in decimal. Or precede the \$ with the PASS character in order to enter hex numbers.

The character selected can be PASSEd in the Convers Mode by using a special PASS character, and will always be passed as data in the Transparent Mode. If operating in the Transparent Mode and you wish to change streams, you must first return to the Command Mode.

See also: maxusers, pass, status

● **SUPCalls [+|-]callsigns|NONE**

v5.0

default NONE

A list of up to 10 callsigns for use with SUPLIST or LLIST. To delete or add individual entries precede the callsign with a "-" or "+" respectively. For example to delete WDØEMR type SUPC -WDØEMR.

See also: llist, suplist

● **SUplist** OFF(NO,NONE)|TO|FROM|BOTH(ON,YES) v5.0

default OFF

When OFF, SUPLIST will allow monitoring of all eligible packets (according to other monitor commands) even if the SUPCALLS list has callsigns in it. When BOTH or ON, packets addressed to or from those stations whose calls are listed in the SUPCALLS will not be monitored. If SUPLIST is TO, only those packets addressed to a station in the SUPCALLS list will not be monitored, those from that station will be monitored. When set to FROM, those packets from the stations in SUPCALLS will not be monitored, but those packets addressed to the stations in the SUPCALLS list will be monitored. Note that SUPLIST takes precedence over BUDLIST. For instance if you have WØABC in your SUPCALLS with SUPLIST TO, and you have WØDEF in your BUDCALLS with BUDLIST BOTH, then packets from WØDEF to WØABC will NOT be monitored.

See also: monitor, supcalls

● **SWp** u,d,t v5.0

default 17,17,108

This command sets the parameters used by the TNC for software carrier detect. The first number (u) is used to increment a counter when a valid mark/space or space/mark transition occurs in the received signal (i.e. transition occurs at the beginning of a bit time). The second number (d) is a penalty subtracted from the counter when a transition occurs in the middle of a bit time. The t value is the threshold value – when the counter total reaches this value, the carrier detect will be set true. Once carrier detect is active, the counter must drop to 0 before carrier detect is again made false.

See also: cd

● **TRACe** ON|OFF v5.0

default OFF

When ON, all received frames are displayed in their entirety, in hexadecimal, including all header information. All packets which are also eligible for monitoring will be displayed in normal text.

● **Trans**

v5.0

immediate

This command causes immediate exit from Command Mode into Transparent Mode. The current link state is not affected. If PARITY is set to NONE you may send all 8 bits from the computer in this mode. There are no special editing characters, all characters are sent out as received. To get out of Transparent, send the TNC a modem break, or see CMDTIME for a special keyboard sequence.

See also: cmdtime

● **TRFlow ON|OFF**

v5.0

default OFF

This command allows the TNC to respond to software flow control from the computer while in the Transparent Mode. When TRFLOW is OFF, software flow control is not used in the Transparent Mode. Hardware flow control will be expected from the computer by the TNC. The computer program needs to use hardware flow control, and the RS-232 cable needs to be wired with CTS and RTS connected. When ON, software flow control is enabled and the START and STOP characters are sent by the computer to the TNC to control the flow of data. When START and STOP are set to \$00, hardware flow control must be used. If not zero, the TNC will respond to the computer's START and STOP characters, and remain transparent to other characters from the terminal or computer.

When START and STOP are set for software flow control (normally <Ctrl-Q> and <Ctrl-S>) all characters can be received in Transparent Mode (including the START and STOP characters) by setting TRFLOW ON and TXFLOW OFF. You will not, however, be able to send the START and STOP characters, since the TNC will interpret them as flow control.

See also: trans, txflow, xflow

● **TRIEs [n] (n = 0 - 15)**

v5.0

The TRIES command will display and optionally set the number of attempts which have been made to re-send a packet (on the current stream) which failed to reach its destination. For instance, if RETRY is set to 10, TRIES will show how many attempts have already been made to pass the data. For example, if TRIES were to show 8, "TRIEs 3" would reset the counter to make the TNC believe that it had only tried 3 times so far, thus allowing 7 more attempts before the RETRY limit is exceeded.

See also: retry

⊗ **TXdelay** n (n = 0 - 255)

v5.0

default 30

This command sets the transmitter key-up delay as $10*n$ ms. This setting establishes the time delay between the application of push-to-talk and AFSK data tones to the transmitter. Flags (character to begin packet) are sent during the delay. This command needs to be set long enough to give your transmitter time to come to full power before data is sent. If set too short the beginning of the packet will be chopped off and another station will never be able to decode you. If set too long additional flags at the beginning (heard as a repetitive sound) just wastes air time. It may be necessary to increase your TXDELAY to allow the receiving station sufficient time for his receiver to detect your signal (i.e. switch from transmit back to receive).

● **TXFlow** ON|OFF

v5.0

default OFF

This command allows the TNC to send software flow control (XON and XOFF) to stop and restart the flow of data from the computer while in the Transparent Mode. When TXFLOW is OFF, hardware flow control must be used between the computer and TNC. RTS and CTS must be connected between the TNC and computer for hardware flow control. When TXFLOW is ON, software flow control between the TNC and computer in Transparent Mode will depend on the setting of XFLOW – XFLOW ON enables software flow control, XFLOW OFF disables it. When software flow control is enabled, the TNC will send the XON and XOFF characters to the computer to control data flow.

When set for software flow control, all characters can be sent in Transparent Mode (including the XON and XOFF characters) by setting TXFLOW ON, XFLOW ON and TRFLOW OFF. You will not, however, be able to receive the START and STOP characters, since your terminal program should interpret them as flow control.

See also: trans, trflow, xflow

⊗ **Unproto** call1 (VIA call2, call3....call9) | [NONE]

v5.0

default CQ

call1 = destination address (this is really just a "dummy" address, as no connection takes place, people often put their name or CQ here)

call2 ... call9 = optional stations to be digipeated through. A maximum of 8 digipeat addresses (callsigns or aliases) can be specified. This is referred to as a path.

Each callsign may also have an optional Secondary Station Identifier (SSID) specified as -n, where n = 1 - 15. The digipeat callsigns are specified in the order in which they are to relay transmitted packets. This command is used to set the digipeat and destination address fields for packets sent in the unconnected (unprotocol) mode.

COMMANDS

July 1, 1992 Version 5.0 KPC-3

Unproto packets do not receive an acknowledgment and are not retried. They are sent as Unnumbered I-frames <UI>. The digipeater list is also used for BEACON and ID packets. If UNPROTO is "NONE", no unconnected packets will be sent except for BEACON and ID. Unconnected packets sent from other units can be monitored by setting MONITOR ON. If you are connected, you must also set MCON ON.

See also: beacon, id, monitor, mrpt, xmitok

● **USers n** (n = 0 - 26)

v5.0

default 1

This command specifies the channels (streams) which may be available to incoming connect requests. For example, if USERS = 5 then an incoming connect request will connect to the lowest channel A - E, if any of these channels are in the unconnected state. If none of the 5 channels are available (all of them are connected), a <DM> packet will be sent back to the requesting station and the message "**** connect request: (call)" will be output to your terminal, if permitted. If USERS is set to 0 no one will be able to connect to you. If USERS is set higher than MAXUSERS, the extra is ignored and the message "USERS LIMITED BY MAXUSERS" will be displayed.

See also: intface, maxusers, streamsw

⊙ **Version**

v5.0

immediate

This command causes the TNC to display its current version number along with the name of the unit.

● **WEFAX n**

v5.0

immediate

This command permits the reception of Weather Facsimile. The audio input is sampled n times per second, and a black/white decision is made on each sample. Each sample becomes one bit of the data sent over the serial port to the computer. A special computer program must be used to display the WEFAX pictures.

See also: daytweak; WEFAX Reception section

● **Xflow ON|OFF**

v5.0

default ON

When ON software flow control will be implemented according to the settings of START, STOP, XON, XOFF. For normal software flow control set XFLOW ON, START \$11, STOP \$13, XON \$11, XOFF \$13. The TNC expects the computer or terminal to

respond to the flow control characters XON and XOFF, and the TNC responds to the START and STOP characters from the computer. When OFF the TNC will only use and recognize hardware flow control lines (CTS and RTS) to start or stop data. The RS-232 cable must be wired appropriately. If the software flow control characters are set to \$00, software flow control is not possible.

In the Transparent Mode flow control is also determined by the settings of TRFLOW and TXFLOW.

See also: start, stop, trflow, txflow, xoff, xon

● **XMitok ON|OFF**

v5.0

default ON

When ON, transmitting functions are enabled. If turned OFF, transmitting is inhibited while all other functions of the TNC are unchanged.

● **XOff n (n = \$00 - \$FF)**

v5.0

default \$13 <Ctrl-S>

This command selects the character sent by the TNC to the computer to stop input from the computer. If set to \$00 hardware flow control must be used. For software flow control set this parameter to the character the computer expects to see to stop sending data to the TNC.

See also: xflow, xon

● **XON n (n = \$00 - \$FF)**

v5.0

default \$11 <Ctrl-Q>

This command selects the character sent by the TNC to the computer to restart input from that device. If set to \$00 hardware flow control must be used. For software flow control set this parameter to the character the computer expects to see to restart sending data to the TNC.

See also: xflow, xoff

Packet Mode

Packet radio is the communication of digital data via radio. A packet is a group of characters with a flag and header at the beginning and a checksum and flag at the end. A flag is a specific character used to signify the beginning and ending of a packet. The header is information concerning who the packet is from, who it is to, any relay stations needed to get to the destination and some control information. A checksum is a complicated mathematical formula that produces a number that is unique to the combination of characters that are in the packet. This unique number is calculated by every station that handles the packet and if it does not match the number that is in the packet, the packet is thrown away, thus error-free communications. A packet is also called a frame.

The Terminal Node Controller (TNC) is the workhorse of packet radio. As a listening device it hears an audio signal from the radio, changes the data to digital form, determines if it is a good packet and sends it to whatever device is attached, usually a computer. As a relay device it also checks the packets it receives and determines if the packets need to be resent, then does so if appropriate. As a sending device it receives digital data from the computer, packetizes it and changes it into audio tones which are sent out to the radio. The rules the TNC uses to do all of this is called a protocol.

The most commonly used protocol in amateur packet radio is AX.25 Level 2 and the nitty gritty details of the inner workings can be found in a book named *AX.25 Amateur Packet-Radio Link-Layer Protocol* available from the ARRL. Most of you are not going to want to go that deep, the TNC takes care of the nitty gritty work for you, although there are parameters you can set that determine how efficiently some of that work is done. In this section of the book we will be discussing the fundamentals of how to get on the air and how parameters interrelate. The default parameters will get most everyone on the air, but by using this information you can change your parameters to be most efficient in whatever situation you find yourself.

Command Mode

In order to change parameters, or give any other instructions to the TNC you must be in Command Mode. This is the mode you will be in when you turn on the TNC. Once you have left Command Mode for any reason there is a parameter called **COMMAND** that determines what special character you will use to return to Command Mode. This comes defaulted as a <Ctrl-C>. (While holding down the control key press "c", then release both.) All parameters are described in alphabetical order in the Commands section. Whenever you enter Command Mode the TNC will send a prompt to your screen that looks like this:

cmd:

Connected vs Unproto

There are two ways to send data in packet radio, connected or unproto (unconnected). In the Connected Mode you first establish a connection. Then your TNC will send packets to that specific station and expects acknowledgments in return. If an acknowledgment is not received the TNC will resend the data (depending on the setting of AX25L2V2 it may send a poll first). The RETRY parameter will determine how many times this is done before the connection is lost due to bad conditions. If the acknowledgment is received the TNC is happy and will send more data, when available. Therefore the Connected Mode, barring impossible conditions, assures that the station you are connected to will receive everything you say, and in the order you say it.

In the Unproto Mode your TNC sends a packet. As far as the TNC is concerned the packet is not directed to a specific station therefore no acknowledgment is expected and no retries are attempted. This mode is often used for calling CQ and informal round table chit chats.

Monitoring and Calling CQ

If you turn the MONITOR command ON you will begin to see other people's packets on your screen. You will notice two callsigns at the beginning of each packet separated by a ">". The first callsign is the station the packet is from. And the second callsign is the station the packet is to. An Unproto packet may have a name or CQ for the second callsign.

To set what will be seen as the "to" callsign for Unproto packets you send, you use the UNPROTO command. This comes defaulted as CQ, but if you wanted to put in your name instead, you would be sure you are in Command Mode and issue a command similar to this:

```
u name<CR>
```

where u is short for unproto, name is your name and <CR> is the return or enter key on your computer keyboard. In order to call CQ you must get into the Convers Mode, so that what you are typing to the TNC will be interpreted as data to be sent out on the air and not as commands. To do this type:

```
k<CR>
```

Now anything you type will be packetized and sent out on the air. Remember to get back to Command Mode you enter a <Ctrl-C> (default) by holding down the Control key while pressing "c". You will be going between Command and Convers Modes depending on if you want to talk to the TNC or have the TNC packetize what you type to go out on the air.

A Simple Connect

Once you see a station you would like to connect to, be sure you are in Command Mode, and issue a connect request, example:

```
c callsign<CR>
```

where `c` is short for connect and `callsign` is the callsign of the station you wish to connect to. If for any reason the connection fails the TNC will send the following message to your screen:

```
*** RETRY COUNT EXCEEDED  
*** DISCONNECTED
```

When your TNC does receive an acknowledgment for a connect packet it will display a message on your screen like:

```
*** CONNECTED TO callsign
```

and your TNC will change to the Convers Mode (dependent on the setting of `NOMODE` and `CONMODE`). Now what you type will be interpreted by the TNC as data to be sent to the other station and not commands to the TNC. The `MCON` parameter comes defaulted to `OFF`. Therefore once you are connected all you will see is what you type and what the other person sends you. Any packets sent by other people will not be monitored.

Two things determine when the data will be packetized. One is the parameter `SENDPAC`. This is defaulted as the return or enter key. So as you are typing your message, whenever you hit the return or enter key you are telling the TNC to make a new packet. A second parameter, `PACLEN`, determines the maximum length of any packet. If you enter data longer than this length a packet will be made even though you have not pressed the return or enter key.

When you have finished your conversation you need to end the connection. To do this you go into the Command Mode and type a "d" for Disconnect. Remember to press the return or enter key after any command to the TNC. Once your station has received the acknowledgment for the disconnect packet the TNC will send this message to your screen:

```
*** DISCONNECTED
```

Either station can issue the disconnect command, no matter which station originated the connect.

Digipeating

Everything we have done so far will only be heard by those within range to hear your signal. With packet radio it is possible to get further than that. The DIGIPEAT parameter in the TNC comes defaulted ON. This makes you a possible relay station, or digital repeater – digipeater, or just digi for short. In many VHF communities one, or more, of these is put up in a good, high location and referred to as a dedicated digi. The TNC and radio is all that is needed for the digital repeater to do its job. A computer would be needed if you wanted to change a parameter, but it would not need to stay there for the digi to work. The higher the antenna, the more effective a digi will be, but remember every TNC has the capability of being a digipeater.

If we turn the MRPT command ON we will begin to see more than just the “from” and “to” stations of the monitored packets. We will also see the callsigns of those stations that have been used as digipeaters. (If you turn HEADERLN ON the headers will end with a return and be on a separate line from the packet data.) This list of stations is often called a path. Here is an example of what you might see:

```
WK5M>KA5ZTX,IAH*,LAG,AUS:
Hi there
```

In this example WK5M is talking to KA5ZTX using the digipeaters IAH, LAG and AUS. The asterisk beside IAH tells you that you are hearing that digipeater. You will notice that IAH, LAG and AUS are not real callsigns. The TNC provides a parameter (MYALIAS) to set up an alias, which is often easier to remember than a callsign. To make this connection WK5M would have typed the following command to his TNC:

```
c ka5ztx v iah,lag,aus
```

v is short for via and up to 8 digis may be used. You must specify digis in the order they will be encountered along the path from your station to the station you wish to connect to. A space must be typed after the “c” and on both sides of the “v”, but digis are separated by commas and no spaces. A path can also be used with the Unproto command:

```
u cq v nom,lch,sli,bix
```

Unproto sets up the path for anything that is subsequently typed in the Convers Mode where no connect exists. Connect issues a connect request to the specified station, via the specified path. Then an error-free conversation can take place between them.

When digipeating the packet goes all the way from the first station, through all relay stations, then to the destination station. Then the response also has to take this same path in reverse. Chances for collisions, therefore retries, are multiplied with every digi used. This is often called end-to-end acknowledgment. Another way to get from one place to another is to connect to a “node”. A node will take care of the acknowledgment between it and the next node or end user. See the KA-Node section for more information. Ask your local packeteers about other types of nodes which may be in your area, such as TheNet, NET/ROM, G8BPQ, and ROSE.

Gateway

In the Kantronics KAM and KPC-4 a Gateway is also available. This is similar to digipeating except that the retransmission of the packet takes place on the other radio port of the TNC from where it was received. In other words, if you are on VHF and send a packet via a Gateway callsign of a KAM your packet would be retransmitted on HF, on whatever frequency the radio connected to the KAM is set for. When you use one of these gateways remember that on HF the baud rate is slower so you may want to lengthen some of your timing parameters. See the KA-Node section for another way to accomplish this with a more reliable connection.

Multi-Connects

The TNC makes it possible for you to talk to more than one person at the same time, if you want to. A stream (or channel) is used for each conversation. The command `MAXUSERS` determines how many streams may be used at one time. And the command `USERS` determines how many people can connect to you. An incoming connect uses the next available stream. If the number of streams set by `USERS` is full, then that station will get a busy message instead of a connect. However, if `MAXUSERS` is set larger than `USERS`, you can still issue outgoing connects on the additional streams.

The character specified in the `STREAMSW` parameter is used to change from one stream to another. The streams are lettered A - Z. So in order to change streams you type the `STREAMSW` character and then the letter designator for the stream you want (no return or enter in this case). This can be done in Command or Convers Modes and the CON and STA lights on the front panel of the TNC will change appropriately for the stream you choose.

For an example, let's assume I'm connected to a WØXI on the A stream of my KPC-3 and also connected to WDØEMR on the B stream. The default `STREAMSW` character is the | symbol, so if I want to transmit a packet to WØXI, I simply enter "|a" to cause my current I/O stream to be the A stream. To then send a packet to WDØEMR I type "|b" to go to the B stream. The current I/O stream when the TNC is first turned on will be the A stream.

The `STATUS` command allows you to see who is on which stream, or the status of the stream, i.e. waiting acknowledgment, connect in progress, disconnected. Turning `STATSHRT ON` will cause the `STATUS` command to list only the current Input/Output stream and any connected streams.

If you are connected and have `MONITOR` and/or `MCON OFF`, the normal headers containing the "to" and "from" callsigns will not be shown. The setting of `STREAMEV` will then determine how often you see the stream designator. This parameter comes defaulted OFF, so the stream designators are only shown when a change in streams

occurs. Turning this command ON will make the stream designators show on every packet. Turning STREAMCA ON will also add the callsign of the "from" station beside the stream designator.

Round Table Discussions

Several people talking together present a difficult situation for packet radio since the protocol requires two stations to connect in order to make sure they receive each others' packets. If you wanted to be absolutely sure that everyone got everything you said you would have to connect to each person and retype everything to each person. That could get a bit cumbersome, so most people use the Unproto Mode and are aware that a collision may occur once in a while. You can usually tell by the conversation if something was missed; if you don't get an answer to a question it's probably not that he is ignoring you, but either the question or the answer got collided with.

With MONITOR ON, the BUDLIST and BUDCALLS commands can help in setting up your monitoring to see only those you want to see. List up to 10 calls in BUDCALLS and set BUDLIST to BOTH. Now you will only see packets "to" and "from" those calls. If you like you may each want to connect to one person, then you know at least that one got what was said, but be sure MCON and MALL are ON.

Timing

Dwait vs. Persistence and Slottime

When the TNC acts as a digipeater, packets that need to be relayed are retransmitted as soon as the frequency is clear. Because of the end-to-end acknowledgment of these kinds of packets it is best for an originating station to avoid colliding with digipeated packets. The TNC provides two ways to accomplish this delay. These two methods are the standard DWAIT method, or the newer PERSISTENCE/SLOTTIME algorithm. During a connect using no digis, this delay also gives the receiving station time to switch from transmit to receive.

Using the DWAIT method, once the TNC detects a clear frequency it will wait DWAIT (times 10 milliseconds) time before beginning to key-up the radio to transmit a packet. This is a packet originated by you not a digipeated packet.

The algorithm used with the PERSIST and SLOTTIME parameters helps avoid collisions by randomizing the wait time before transmitting. The more random the timing the less chance of two TNCs transmitting at the same time and colliding.

Once the TNC detects a clear frequency it will wait SLOTTIME (times 10 milliseconds). Then it will generate a random number. If this number is smaller than the setting of PERSIST the TNC will transmit. If it is larger it will wait another

SLOTTIME and then generate another random number and again decide whether to transmit or not. When using PERSIST and SLOTTIME you should set DWAIT to 0, since both will be used if specified.

As an example, let's assume that PERSIST is set to 63, and SLOTTIME is set to 10. This value of SLOTTIME results in a random number being generated every 100 milliseconds. When the TNC sees that the channel is clear, it waits 100 ms, then generates a random number between 0 and 255 (inclusive). If, in our example, the number was 83, then the TNC would not start the key-up of the transmitter since 83 is greater than the 63 PERSIST value. Instead, it would wait an additional 100 ms, and if the channel is still clear, generate a new random number. This time, let's say it comes up with the number 27. Since this is less than the PERSIST value, we now start the key-up of the transmitter to send the packet.

Txdelay

TXDELAY should be adjusted to allow your radio sufficient time to switch from the receive mode to transmit and develop full power output. If the TNC sends the packet before the radio is at full power the beginning of the packet will be lost and no one will be able to decode it. It is a good idea to allow a little extra time for this parameter to allow the station you are talking to sufficient time to switch from his transmit mode back to receive. This is not usually necessary if you are connected through a digipeater, but if you are connected direct, this could make the difference between successful communications and no communications. The TNC sends flags during this period, so if someone has this set extra long you will hear a repetitive sound at the beginning of the packet.

Frack

Frame acknowledgment time. If the TNC expects an acknowledgment of a packet it has sent, it will wait FRACK seconds for the acknowledgment. If the acknowledgment is not received it will either send a poll or retransmit the packet, depending on the setting of AX25L2V2. When digis are used, extra time is allowed for each transmission using the following equation:

$$\text{FRACK} * ((2 * n) + 1) \text{ seconds}$$

where n is the number of digipeaters. The lower the baud rate (HBAUD) the longer this parameter should be set, because everything is slower. The length of the transmission (determined by PACLEN and MAXFRAME) also needs to be taken into account when deciding how to set FRACK. Longer packets (and more of them) require more time to be transmitted, more time to be repeated by the digipeater, and so on down the line. The FRACK timer begins when PTT is released (the packet has been sent) and is suspended when data carrier from the radio is present, or when your station is transmitting.

Retries AX.25 Level 2, Version 1 vs. Version 2

The way retries are accomplished depends on AX25L2V2 being OFF or ON. To explain this we will follow a conversation through its path. First let's assume station "A" is connected to station "B" with Version 1 protocol (AX25L2V2 OFF). When station A sends a packet to station B, he expects to receive an acknowledge back indicating that station B has received the information. In order to verify that the proper packet (or frame) has been acknowledged, each frame has a number. This number is sent as a part of the frame so the receiving station knows where this packet belongs in the conversation. The frame numbers range from 0-7 and because of this, we are limited to a MAXFRAME of 7 (we do not want the same frame number reused in the same transmission). This is also true for Version 2. If the first acknowledge is received, there is really no difference between the two versions, practically speaking. The difference shows up with retries, so let's assume that the packet did not get through on the first attempt.

Let's now assume that station A sends frame number 3 to station B. Station B does not receive the frame and therefore no acknowledge is received by station A. With version 1, the entire packet is retransmitted (with the same frame number), again to station B and this continues until station A receives an acknowledge from station B. This acknowledge can take two basic forms. The first time station B receives frame 3 he will send an acknowledge of the form "ready to receive frame 4" <rr4>. If this acknowledge is sent, and station A did not receive it, station A will again send frame 3. Since station B already received frame 3, he would acknowledge it with the form "I've already got frame number 3" <rej4>. This is also known as Reject Frame sent. This process would continue until the retry count is exceeded when, under version 1, the sending TNC will initiate a disconnect and discard the packet. (The monitoring of the commands in < > depends on the settings of MRESP and MCON.)

Now let's look at the same conditions under version 2 (AX25L2V2 ON). Station B does not receive the frame and therefore no acknowledge is received by station A. This time, station A sends a POLL or question to station B saying, in effect, "did you receive my frame number 3?" <<RR3>>. Since station B did not receive the frame, he would respond with a "no I did not" <<rr3>>. This really says "I am ready to receive frame 3". At this point, station A, upon receiving the rr3 would immediately resend the entire frame. If station B had already received frame 3 once but the acknowledge never got to station A the question from station A for the retry would be the same. Station B's response however, would be different. He would respond with "ready to receive frame 4" <<rr4>>. If station A does not receive station B's reply this "POLL/REPLY" sequence would continue for the number of retries set in the sending TNC and if no response was received, the TNC at station A would then begin to issue connect requests to station B since there is still an outstanding packet of information. This is the major difference between version 1 and version 2. The connect attempts would then continue for the number of retries set in the TNC and if no response was received from station B after all of the above, station A would disconnect and discard the packet. The parameter RELINK is defaulted OFF to avoid the reconnect attempt.

Flow Control

The flow control commands insure that the TNC gets everything that is sent to it by the computer and that the computer gets everything the TNC sends it. When the computer sends the TNC data the TNC stores this data in a buffer until it can packetize it, send it, and get acknowledgments. When the TNC sends the computer data it also stores it in a buffer until it can be processed, stored to disk, sent to printer, or whatever. This buffer area is only so big, if more data is sent than will fit in the buffer it is lost. To avoid this the two devices can tell each other to start and stop sending data. This is called Flow Control and can be accomplished in two ways, software and hardware. Which way you implement this depends on the capabilities of your computer communications program and personal preference. The cable between your computer and TNC must also be wired appropriately.

Software Flow Control

Software flow control sends special characters on the TXD and RXD lines of the RS-232 cable. These are the same lines used for sending regular data between the TNC and computer. Software flow control normally sends a <Ctrl-S> to stop data and a <Ctrl-Q> to restart data. When a buffer gets close to full the device will send a <Ctrl-S> and expect the other device to stop. When the buffer gets emptier it will send a <Ctrl-Q> to tell the other device to send more data. How full or empty a buffer is when the special characters are sent is determined by the program. But, since the regular data lines are being used a <Ctrl-S> sent from the keyboard will also stop data. And likewise, if there is a <Ctrl-S> in a file being sent, data flow will stop until a <Ctrl-Q> is received.

XFLOW needs to be turned ON for the TNC to use software flow control. XOFF determines the character sent by the TNC to stop the flow of data from the computer, and the XON character restarts the flow. The TNC expects the computer to send the STOP character to stop data and the START character to restart data. To use software flow control these commands would be set as follows: XFLOW ON, XOFF \$13, XON \$11, STOP \$13, START \$11.

In the Transparent Mode two more commands are provided that make it possible to send or receive these special characters and still use software flow control. TXFLOW controls flow control sent by the TNC to the computer and TRFLOW controls what the TNC expects from the computer. If both these commands are ON (and the above commands are set as stated) then software flow control will take place in both directions, to and from the TNC and computer. But if you are in Transparent Mode sending a file the computer is not going to be telling the TNC to stop and start since you are sending the file. But if there is a <Ctrl-S> in the file, the TNC will think the computer is telling the TNC to stop and will not send any data to your computer until it receives a <Ctrl-Q> (even if you have completed sending the file). To solve this problem you can turn TRFLOW OFF and send all characters and turn TXFLOW ON so the TNC will still tell the computer when to stop and restart. On the other hand, if receiving a file set TRFLOW ON and TXFLOW OFF.

Hardware Flow Control

Hardware flow control monitors the voltages on the RTS and CTS pins of the RS-232 cable. Therefore these two wires must be in the cable between your TNC and computer. The TNC holds CTS high as long as it can receive data. Once its buffer gets full it pulls this line low. The computer program monitors this line and when it is pulled low knows to stop sending data. When the line is again pulled high by the TNC the computer program will restart sending data. On the other hand the computer holds RTS high as long as it can receive data and pulls it low to tell the TNC to stop sending data. The TNC always uses hardware flow control, so only wire the RTS and CTS pins if your computer program is also using hardware flow control.

Convers Mode vs. Transparent Mode

In the Convers Mode there are many special characters. To list a few:

Command	Default	Description
SENDPAC	<Ctrl-M>	Causes a packet to be packetized
DELETE	<Ctrl-H>	Backspace character
REDISPLAY	<Ctrl-R>	Redisplays the keyboard buffer
CANLINE	<Ctrl-X>	Cancel a line
STOP	<Ctrl-S>	Stops output from TNC to computer
PASS	<Ctrl-V>	Pass a special character

These characters are all very useful when having a packet conversation with someone. If you want to send a packet you hit the return. If you make a mistake you can backup with the delete or backspace key, or kill the whole line with <Ctrl-X>. And if you really want to send one of these characters you can always precede it with a PASS character.

Transparent Mode is made more for the sending of files, whether they be ASCII data files or program files. The special characters do not mean anything to the TNC, they are just characters to be put in a packet and sent to the radio. (XOFF, XON, STOP, START may be used depending on the settings of XFLOW, TXFLOW and TRFLOW, see the flow control section.) A SENDPAC character will not cause a packet to be packetized, instead this is controlled by a timer (PACTIME). This way short lines do not make short packets, therefore less overhead and more efficient use of the frequency. How congested the frequency is should be kept in mind when setting the PACLEN and MAXFRAME parameters.

All monitor commands are treated as OFF in Transparent Mode. All you will see is what is being sent to you. You would probably want to set USERS to 1 so no one interferes with the transfer. The setting of ECHO is also ignored. Even if ECHO is ON Transparent Mode will not echo to the attached terminal. Some programs allow for local echoing to the screen while uploading.

Getting Out of Transparent

Getting into the Transparent Mode is easy, you just type a "t" in Command Mode. But since Transparent Mode allows the sending of all characters you can not get out of Transparent Mode by just typing a Ctrl-C (COMMAND character) as in Convers Mode. In order to get out of Transparent Mode you must follow a special sequence, or use a modem break if your program supports one. The special sequence must be followed precisely. This example assumes the COMMAND character is <Ctrl-C> and CMDTIME is 1 second:

- Wait at least 1 second since the last character was sent from the computer to the TNC
- Type a <Ctrl-C>
- Within 1 second type a second <Ctrl-C>
- Within 1 second type a third <Ctrl-C>
- Wait 1 second and the cmd: prompt should appear

If the guard time of one second before and after the three <Ctrl-C>s is not there the TNC assumes that they are data and sends them to the radio. Don't get impatient, one second can seem longer than you think it should.

PBBS (Personal Mailbox)

General

Your KPC-3 contains the Kantronics Personal Mailbox system which will allow you to leave messages for others which may be retrieved later. The personal mailbox is compatible with the large community bulletin board systems (RLI, MBL, etc) and will allow them to forward mail for you directly into your KPC-3. You may also place messages in your mailbox, and if the local Community BBS system allows, your KPC-3 mailbox will reverse forward these messages from your personal mailbox into the community system on request. The PBBS supports Bulletin IDs (BIDS), Message IDs (MIDS) and Hierarchical forwarding designators.

Configuring your PBBS

When you first enter your callsign into the KPC-3, your PBBS will automatically be enabled. The MYPBBS callsign is set to your basic call with an SSID of -1, and the PBBS is allocated 5K of RAM. You may change the size of the PBBS using the PBBS command. The maximum amount of memory you can allocate will depend on the amount of free memory available. NUMNODES, MAXUSERS, and MYREMOTE will affect the amount of available memory.

If you change the size of the mailbox, the KPC-3 will not renumber any existing messages, and if the new size is large enough for all existing messages, no messages will be lost. If you want to renumber the messages (starting with 1) give the PBBS n command with n being the current size.

At times, you may be away from your computer and would like to switch a user into your mailbox automatically if he connects to your MYCALL. This can be accomplished by setting the CMSG command to PBBS. When this is done, a user who connects to your MYCALL will be sent your CTEXT (if any) and then be automatically connected to the PBBS. The KPC-3 will then send the PBBS System ID (SID) and sign on message. The SID is enclosed in square brackets and consists of the unit name, firmware version, and the supported feature set. For example the KPC-3 SID is:

[KPC3-5.0-HM\$]

This is the unit name (KPC3), version number (5.0) and the feature set (HM\$). The H means it supports Hierarchical forwarding, the M stands for Message ID, and the \$ indicates BID support. These identifiers are according to the SID definitions published by Hank Oredson (WØRLI) with his Community BBS system.

You can customize a greeting message to be sent to a user who connects to your PBBS by using the PTEXT command. This command accepts up to 128 characters as a text string to be sent to the user immediately after the SID is sent.

If it becomes necessary to disconnect a station from your PBBS, you can use the local terminal connected to your KPC-3 to accomplish this (see DISCONNECT MYPBBS). If a station connects to your PBBS and no activity occurs on the connection for 15 minutes, the PBBS will automatically disconnect the user in order to make your PBBS available to others.

If a community bulletin board forwards messages into your PBBS, it sends you many lines beginning with R:. These are routing headers that show the complete path taken by this message. By default, these headers will be stored in your PBBS with the message. If you choose, you may prevent your PBBS from storing these by setting the PBHEADER command OFF.

If you want your PBBS to only accept messages for you, you can set the PBPERSON command ON. When set ON, this command will make your PBBS only accept messages that are addressed to your MYCALL or MYPBBS.

Finally, the PBLO command is used to determine the order in which messages are listed to a user. When set to OLD, messages will be sent oldest first (message 1, then 2, etc). When set to NEW, the most recent message will be listed first. The second parameter of this command determines whether or not you will allow a PBBS user to change the listing order. When set to FIXED, the user cannot change the order, and when set to VARIABLE, the user may change the order by connecting to the PBBS and using the LO command.

Using the PBBS

In order to use any KPC-3 PBBS (even your own) first, get the cmd: prompt on your KPC-3, and then connect to the callsign of the PBBS. For instance, if MYPBBS is WK5M-1, I would simply type C WK5M-1. Since the PBBS is in my own KPC-3, no packets would be transmitted, but I would connect to the PBBS and receive the same prompt as if I had connected to someone else's PBBS.

When you connect to a KPC-3 PBBS, you will first see the message from your KPC-3 indicating that you are connected:

```
*** CONNECTED to WK5M-1
```

The PBBS will then send you its initial sign on message. If you have defined a PTEXT, the KPC-3 will send it as the next line, and then it sends the PBBS command prompt. Example:

```
[KPC3-5.0-HM$]
4528 BYTES AVAILABLE
PTEXT would be here (if any)
ENTER COMMAND: B,J,K,L,R,S, or Help >
```

Using the PBBS is therefore the same, whether you are using your own PBBS or another persons PBBS. At this point you are ready to send a message to another user, or issue any other mailbox command.

Let's assume I want to send a message to KA5ZTX. I would now use the Send Private command:

```
SP KA5ZTX
```

and the KPC-3 responds with:

```
SUBJECT:
```

I now enter a short subject line:

```
Just a quick question
```

the KPC-3 responds with:

```
ENTER MESSAGE-END WITH CTRL-Z OR /EX ON A SINGLE LINE
```

Now you enter the text of your message. To end the message and have it saved, type a <Ctrl-Z> (hold down the control key and press Z) or type /EX. The <Ctrl-Z> or /EX must be on a line by itself - do not type anything else on this line. When the message has been ended properly, the PBBS responds with:

```
MESSAGE SAVED
ENTER COMMAND: B,J,K,L,R,S, or Help >
```

You may now enter more mailbox commands. The commands available in the KPC-3 PBBS are:

B(ye)

This command causes the PBBS to disconnect you from the PBBS.

E(edit) n [BPTYNFH] [>tocall] [<fromcall] [@BBS]

This command is only available to the SYSOP (i.e. owner) of the PBBS. It allows you to edit the message header of any message in the mailbox, changing the TYPE of message:

- B - Bulletin
- P - Private
- T - Traffic

the STATUS of the message:

- Y - Yes [it has been read]
- N - No [it has not been read]
- F - Forwarded [it has been forwarded]
- H - Held [it is not available for reverse forwarding]

who the message is to or from:

- >tocall
- <fromcall

and the destination mailbox (@BBS):

@BBS[.haddr]

When a message is listed, the "tocall" and "fromcall" appear in the TO and FROM columns, respectively. If a message has been entered with an "@BBS" for forwarding, the complete hierarchical address is shown when the message is read:

MSG2 02/10/92 10:30:58 FROM KA5ZTX TO HELP @wa4ewv.#stx.tx.usa.noam

The @BBS is also listed when using the semi-colon (;) option with any of the list commands.

You can access the Edit command by connecting to the mailbox from the attached terminal, or by connecting over the radio. If you connect over the radio, your MYCALL must be the same base callsign (excluding SSID) as the MYCALL of the KPC-3 containing the mailbox, and the FIRST command you give to the mailbox must be SYSOP. When you give the SYSOP command, the PBBS will send you a password verification string which must be properly responded to in order to gain SYSOP access. This is explained in detail later.

Let's say you want to edit message number 2 which currently is a PRIVATE message addressed to WØXI. The message has been read by WØXI so it shows a status of Y. It may list as:

MSG#	ST	SIZE	TO	FROM	DATE	SUBJECT
2	PY	53	WØXI	WK5M	01/14/92 03:36:45	Good afternoon

Now I want to change this so that it is addressed to WDØEMR and also change the Y flag to N to show that it hasn't been read. To do this, you connect to your PBBS (either from the KEYBOARD or as SYSOP over the radio), and issue the command:

```
e 2 N >WDØEMR
```

You could do this with two separate commands, or it may be accomplished with the single command shown above.

H(elp)

This command displays a HELP menu.

J(heard)

This command displays a list of stations recently heard by the KPC-3. The list will include a date and time stamp indicating when each station was heard.

J S(hort)

This command is similar to the J(heard) command above, but only displays the callsigns of the stations heard.

J L(ong)

This command is similar to the J(heard) command above, but also displays any digipeaters used by the stations it has heard and the destination callsign.

L(ist) [;]

This command will list all messages in the mailbox which you are allowed to read. This will include all BULLETINS, TRAFFIC, and any PRIVATE messages addressed TO you or sent by you. (If you are the SYSOP (keyboard or remote) ALL messages will be listed). Specifying the optional semi-colon (;) in any List command will also show the @BBS and BID of the messages (if any).

L <!> call [;]

This command allows you to list only those messages in the mailbox which are addressed to a specific callsign (>), or which were sent by a specific callsign (<). To list only those messages addressed to AMSAT for instance, you would give the command L> AMSAT.

LB [;]

This command will list all BULLETINS in the mailbox.

LC [cat [;]]

Using the LC command by itself will cause the PBBS to list the TO field of all BULLETINS in the mailbox. This will just be a list of the actual TO fields, and not a list of the messages. If you specify a category (i.e. LC RACES) the PBBS will list the full message headers of all BULLETINS addressed to that category.

LL n [;]

This command will list the most recent n number of messages in the mailbox. Again, only BULLETINS, TRAFFIC, and PRIVATE which you are allowed to read will be listed.

LM(ine) [;]

The LM command will list all messages in the mailbox which are addressed to you.

LO [+|-]

This command allows you to change the order in which messages are listed. When set to +, the messages are listed in ascending numerical order (oldest to newest). When this command is set to -, the messages will be listed starting with the highest message number (newest to oldest). This command will not be available if the SYSOP has the PBLO command in his KPC-3 set to FIXED.

LT [;]

This command will cause the PBBS to list all TRAFFIC messages that are currently in the PBBS.

K(ill) n

This command will delete message number n from the mailbox. You may only delete TRAFFIC messages, PRIVATE messages addressed TO or FROM you, or BULLETINS you sent. The SYSOP may delete any message, including BULLETINS.

KM(ine)

The KM command will delete any messages in the PBBS which are addressed to you and that you have read. If you have not read a message addressed to you, it will not be deleted.

R(ead) n

The Read command is used to read a specific message by number. Only PRIVATE messages address TO you, or sent by you, may be read, as well as any BULLETIN or TRAFFIC messages. After you read a PRIVATE message addressed to you, the STATUS flag will automatically be set to Y – it has been read.

RM(ine)

The RM command will cause the PBBS to display all messages in the PBBS which are addressed to you, if you have not already read them.

S(end) call

The Send command will send a PRIVATE message to the callsign specified. This is the same as using the preferred SP command.

SB cat

The SB (Send Bulletin) command is used to send a BULLETIN to the PBBS.

SP call

The SP (Send Private) command will send a PRIVATE message to a specified callsign. This is the same as using the Send command.

ST zip

The ST (Send Traffic) command is used to send NTS type traffic messages to the PBBS.

Some of these commands are described in more detail below.

Sending Messages

The SEND command (and its many forms) allows the following syntax:

```
S call [@ bbscall[.haddr]] [$ mid]
SP call [@ bbscall[.haddr]] [$ mid]
ST zip [@ location[.haddr]]
SB cat [@ location[.haddr]] [$ bid]
```

where:

call is the callsign of the station the message is addressed to.

bbscall is the callsign of a full service BBS where the message should be delivered.

haddr is the complete Hierarchical address designator for the BBS system or destination of the message. (Contact your local community BBS SYSOP for complete information on Hierarchical addressing.)

location is the designator used for distribution of the message. For TRAFFIC, this should be NTSxx where xx is the two letter POSTAL code for the state.

mid is the MESSAGE ID assigned to the message by the originator.

bid is the BULLETIN ID assigned to the message by the originator.

zip is the 5 digit postal zip code (or postal code)

cat is the message category. For instance, a message requesting help on a subject may be sent to the category HELP, info sent to INFO, items for sale to SALE, etc. Contact your local community BBS SYSOP for some other examples and suggestions.

Some examples of commands would be:

SP WB5BBW @ W5AC.#STX.TX.USA.NOAM

this command sends a private message to WB5BBW. The message should be sent to the W5AC BBS system, in South Texas (.#STX), which is in Texas (.TX), which is in the USA (.USA), which is in North America (.NOAM) where WB5BBW can retrieve it.

ST 88030 @ NTSNM

this command sends an NTS traffic message to a non-ham, or to someone who is not on packet, living in zip code 88030 which is in New Mexico. The location field contains the NTSxx (xx = NM) to indicate that the 88030 zip code is in New Mexico.

SB RACES @ ALLUS \$RACESBUL.010

this command sends a bulletin addressed to RACES, which should be sent to all BBS system in the USA (ALLUS) and has been assigned the Bulletin ID (BID) RACESBUL.010. This BID prevents the same message from being duplicated as it travels throughout the BBS system.

When you send a message to the PBBS, you must include the @BBS (bcall[.haddr]) field if you want the message to be reverse forwarded from the PBBS to a full-service BBS system. Any message entered into the PBBS over the radio will initially be marked with a status of H (held) and will not be reverse forwarded until the SYSOP has edited the message header and changed the H flag. This gives the SYSOP full control over the messages relayed by his station.

Messages entered from the local keyboard connected to the KPC-3 do not require editing in order to be reverse forwarded, but must include at least an @BBS field to enable the reverse forwarding.

Listing Messages

When you list messages with any of the LIST commands, you will get a display similar to the one shown below. If you specify the optional semi-colon (;) you will also see the @BBS field in square braces after the message.

MSG#	ST	SIZE	TO	FROM	DATE	SUBJECT
6	B	45	KEPS	W3IWI	12/19/91 09:37:11	2 Line Element set
4	B	26	HELP	WB5BBW	12/19/91 09:34:05	Xerox 820
3	T	38	66044	WØOUU	12/19/91 09:33:42	QTC Lawrence 913/842
2	PN	14	NØAPJ	WØSC	12/19/91 09:33:27	AMTOR
1	B	30	ALL	WK5M	12/19/91 09:32:49	Need help on AMTOR

9712 BYTES AVAILABLE

NEXT MESSAGE NUMBER 7

ENTER COMMAND: B,J,K,L,R,S, or Help >

The message number (MSG#) is listed, followed by the STATUS of the message. This status includes the message type (B=Bulletin, T=NTS traffic, and P=Personal message). The second character in the ST column is the current status of the message.

A Bulletin status can be:

F – it has already been forwarded to another full-service BBS

H – it is being held for review by the SYSOP because it was entered into the PBBS over the radio.

An NTS traffic message (type T) may have a status of H, indicating that it is being held for review by the SYSOP before it may be reverse forwarded.

The type P message (Private) can have the following characters in the second position:

H – This is a personal message that has an @BBS field but is being held for review by the SYSOP before it may be reverse forwarded.

N – This message is a Personal message that has not been forwarded and has not been read by the station it is addressed to. If it is forwarded to a full-service BBS, it will automatically be deleted.

Y – This message has been read by the station it is addressed to, but has not been killed. It will not be forwarded even if it has an @BBS since it has already been read.

Remote SYSOP access to the PBBS

Using the PBBS over the radio link and editing messages that are already in your PBBS can be accomplished by entering the SYSOP command as your first command to the PBBS. When you enter this command, you will receive three sets of numbers from the PBBS. These numbers indicate the character positions of the RTEXT to be used as the password for this log on.

For instance, let's say my RTEXT is:

This is a sample rtext.

Now when I give the SYSOP command, the KPC-3 might respond with:

```
1 12 3 18 6 9
2 10 22 5 7 18
13 16 4 9 1 20
```

If I choose the first set of numbers, I should send the following as a response:

Tairia

(T is the 1st letter, a is the 12th letter, i is the 3rd letter, and so on. See the RTEXT command in the Commands section for a more detailed explanation.)

NOTE: Spaces DO count as characters, and case is significant!

Reverse forwarding messages from your mailbox

The Kantronics KPC-3 mailbox will allow you to enter messages which will be forwarded by full-service BBSs (RLI, MBL, etc). These messages have a special format, and can be entered in any personal mailbox. Let's suppose I want to send a message to WA4EWV who lives in Texas. I know his home BBS is WB5BBW, so I can put this message in the PBBS with the command:

```
S WA4EWV @ WB5BBW
```

Entering an @ BBS will cause the KPC-3 to reverse forward this message to a full service BBS when requested by the full service BBS. In order to improve the chances of this message reaching its destination, you should always enter the message with complete hierarchical forwarding:

```
S WA4EWV @ WB5BBW.#STX.TX.USA.NA
```

Complete information on Hierarchical forwarding can be obtained from your local BBS system operator, but basically the first field after the @ symbol is the HOME BBS of the station you are trying to send a message. The next several fields

(separated by periods) are the state (two letter postal abbreviation), country, and continent. In this case, since Texas is so large, it is sub-divided into smaller areas. These are indicated with the # symbol (in this case #STX – South Texas).

Messages entered into your mailbox in this format will be reverse forwarded to the full service BBS when requested, and the following rules apply:

The KPC-3 acts like a "smart BBS" when forwarding to or from a full service BBS. This means that it will no longer send the SUBJECT: prompt, nor will it send the ENTER MESSAGE prompt. You will also notice that when a full-service BBS connects to your PBBS, the KPC-3 does not send the usual ENTER COMMAND prompt, but only the > is sent. This is designed to reduce the amount of data on the packet network, since "smart" BBSs know what is expected of them.

Once a Private or Traffic message has been successfully forwarded out of your mailbox, it will be deleted from the PBBS. Bulletins will be marked with a status of "F" and will remain in the PBBS.

KA-Node

General

The Kantronics KA-Node is a part of your KPC-3, which provides users with local acknowledgments of packets, rather than the end-to-end acknowledgments required when connecting to distant stations with digipeaters. This feature is useful when connecting to distant stations, and generally results in a significant increase in data throughput. If you connect to a dual-port Kantronics KA-Node (the KAM or KPC-4) you may also "gateway" from one port to the other using the commands described under "Using a KA-Node". This would allow a VHF user to access HF packet frequencies by using such a KA-Node. Each packet you send to a KA-Node is acknowledged by that KA-Node and also passed to the next station in the path. Since the data has been acknowledged from your station, any retries which are required due to collisions or other conditions will be automatically performed by the KA-Node.

Frequently when connecting to a distant city, you may wish to talk to more than one station. Perhaps when you connected, you got a message saying "I'm not here right now, please leave a message in my PBBS". By using the "S(tay)" option when telling a KA-Node to connect to another station, the KA-Node will not disconnect from you if it receives a disconnect from the distant station. Instead, you will receive a message from the KA-Node saying "###DISCONNECTED BY (call) AT NODE (MYNODE)". In other words, if I connected from Lawrence, Kansas to a KA-Node in Lincoln, Nebraska, and then told that KA-Node to connect to someone using the command "C call Stay". Then if that station sent me the above message and disconnected, I would remain connected to the KA-Node in Lincoln! This now would allow me to issue a connect directly to his BBS, without having to re-establish the entire path.

In multiple KA-Node paths, each time you say B(ye) to the distant KA-Node, this would return you to the next previous KA-Node which had been told to "Stay" in the chain of KA-Nodes. From that point, you could build a path in a different direction. One point to note here, is that if you use the KA-Node to connect to a BBS (WØRLI or WA7MBL for instance), and use the STAY option, then say B(ye) to the BBS, you would remain connected to the KA-Node closest to the BBS. If you issue the connect without the STAY option, any disconnect from either end will cause the entire link to disconnect.

The KA-Node checks the passage of data through the node, and if no activity occurs for some preselected time (see KNTIMER) then the KA-Node will disconnect both sides of the node.

Configuring Your KA-Node

In order to set your Kantronics KPC-3 for use as a KA-Node several conditions must be met. First, you must allocate the number of circuits you wish to allow through the KA-Node (see NUMNODES). Each circuit consists of an "IN" and an "OUT" side. Secondly, the callsign assigned to the KA-Node (MYNODE) must be different from the callsign used for you (MYCALL), your alias (MYALIAS), the PBBS (MYPBBS), and remote access (MYREMOTE). By default, your KPC-3 has set MYNODE to your callsign with an SSID of -7.

If desired, you may set the NDWILD command ON. This will cause your KA-Node to accept a connect request to any SSID of the MYNODE callsign, except those mentioned above. Packets passing through your KA-Node are monitored unless your MYNODE callsign is included in the SUPCALLS list and SUPLIST is turned ON. If it becomes necessary to disconnect a station from your KA-Node, you can issue the command DISCONNECT MYNODE, from the local terminal connected to your KPC-3.

Each KA-Node circuit allowed will require approximately 4.3K of memory. If you attempt to set NUMNODES to a value requiring more memory than available, you will receive a message indicating that the value is out of range or not enough RAM. The total number of circuits which may be allocated will also be affected by the amount of memory allocated to the Personal Mailbox.

Using a KA-Node

To use the KA-Node as a means of connecting to some other node or end-user, you must first connect to the KA-Node. At the cmd: prompt on your KPC-3, issue a connect request to the callsign of the KA-Node, let's say LAW. When you make connection you will see the following messages on your display:

```
*** CONNECTED TO LAW
### CONNECTED TO WILD NODE LAW (WDØEMR) CHANNEL A
ENTER COMMAND B,C,J,N,X, or Help ?
```

The *** CONNECTED message is sent by your local KPC-3 to the terminal, and the ### CONNECTED TO NODE message is coming from the distant KA-Node. WDØEMR is the MYCALL of the station containing the KA-Node in this example, WILD indicates that he is running a "wildcard" node, and CHANNEL A indicates that you have connected to its channel A. If A is in use, you may obtain channel B. The channels, or circuits, are assigned by the KA-Node as needed.

After connecting to the KA-Node, you are in CONVERS mode at your own station, but the KA-Node is waiting for a command. You issue a command to the node by STAYING IN CONVERS MODE. The KA-Node will interpret the data you send as its commands. It can receive only commands; it doesn't know what data is. At this point,

let's assume that you wish to know what other KA-Nodes are nearby. You would issue the NODES command by typing N, or NODES, in response to the KA-Node "enter command" prompt. You will receive a list of KA-Nodes which have recently been heard. For example, let's suppose that KC was heard by LAW. Your list received from the Nodes command would be:

```
KC (NØAPJ-2) 12/23/87 02:38:45
ENTER COMMAND B,C,J,N,X, or Help ?
```

KC denotes the KA-Node callsign, the MYCALL of the KA-Node station is in parentheses, followed by date and time heard. If LAW had heard nothing, it would respond with:

```
NO KNOWN NODES
```

You may, instead, wish to know what other stations the KA-Node has heard lately. This would be accomplished by sending the JHEARD command. The node will respond by listing its own MHEARD log. The list will contain end user and node callsigns and is the same type of list you get by using your own MHEARD command at the cmd: prompt.

At this point, let's suppose that you would like to connect to the node called KC through your current connection with LAW. Just issue a connect request to KC as follows in response to the "enter command" from LAW:

```
CONNECT KC
```

The response will be:

```
###LINK MADE
###CONNECTED TO NODE KC (MYCALLSIGN OF KC) CHANNEL A
ENTER COMMAND B,C,J,N,X, or Help ?
```

At this point you are "patched" through the KA-Node LAW to the node KC. When LAW issued the connect request to KC it used your own call but subtracted a count of one from your SSID. For example, if you connected to LAW with WØXI, LAW connected (via your request) to KC with WØXI-15. This is automatic. At this point, you could connect to another KA-Node, some other network node using AX.25 as an uplink or downlink protocol, or to an end-user. Let's assume that you desire to connect to NØAPJ. So, just enter in response to the node "enter command" above:

```
C NØAPJ Stay
```

and you'll get the response:

```
###LINK MADE
```

You are now connected to NØAPJ. If you have issued a connect command to a KA-Node, and realize that you have made a mistake with the call, or for any other reason wish to cancel the connection, you may do so by using the ABORT command. In order for the abort to work, it MUST be the first word entered following the connect command and must be spelled out entirely. For instance if you tell the KA-Node:

XC KB5EEG

and then decide to abort the connect, your next entry must be:

ABORT

any other entry will cancel any possible abort of the connection, and you must wait for the KA-Node to retry out.

Now that you are connected to NØAPJ, you can carry on a normal packet QSO. While everything appears "normal" and AX.25 compatible, acknowledgments to your packets are generated by the KA-Node directly connected to you. Each channel in the link takes care of its own errors. In other words, the link between KC and LAW handles its own error checking. In this way, one weak link will not cause end-to-end packets and acknowledgments to be repeated as they would with digipeating. The result is substantial improvement in throughput for connections using nodes.

When it comes time to disconnect, you do so in the standard AX.25 manner. To disconnect the link described above, type <Ctrl-C>, obtain the cmd: prompt on your KPC-3, and issue the disconnect command:

```
cmd: D
***DISCONNECTED
```

You'll get the usual disconnect message from your KPC-3 as noted. If however, your distant partner, in this case NØAPJ, disconnects the link, you'll see the following:

```
###DISCONNECTED BY NØAPJ AT NODE KC
ENTER COMMAND B,C,J,N,X, or Help ?
```

Automatic Disconnect

If a user abandons a connection to a KA-Node or a link between two KA-Nodes without disconnecting and there is no activity through the link for a specified period of time (see KNTIMER), the node will initiate a disconnect.

Using the XCONNECT Command (KAM and KPC-4 only)

The cross-connect (XCONNECT) command is a unique feature of the KA-Node. This command allows cross linking between two frequencies through the node in much the same manner as the Kantronics unique gateway, but with local acknowledgment of packets.

For example, suppose you just connected to node LAWKAN and wish to cross-connect to WDØEMR whose station is tuned to the frequency of the other port of the node. Just issue XC WDØEMR following the the node prompt:

```
ENTER COMMAND B,C,J,N,X, or Help
?XC WDØEMR <CR>
```

The response you receive will be:

```
### LINK MADE
### CONNECTED TO WDØEMR
```

You can also determine from the response to the NODE command, which port a node is on. Below is an illustration of a KA-Node response to a NODE command:

```
LAWKAN*    12/02/87 15:45:00
N66046/X   12/02/87 15:49:15
OLAKAN/X   12/02/87 16:15:21
```

In this typical display the callsign of the node is given, followed by the date and time it was last heard. The slant bar X (/X) indicates that the node was heard on the opposite port from the one you are connected on. The asterisk (*) means that the node was heard via a digipeater.

Determining Which Port You Have Connected To

When you are connected to a KPC-4 or KAM node, you can determine which port you are on, at the node, by using the JHEARD command. A typical node response to the JHEARD command may appear on your display as shown (the KAM uses /H and /V instead of /1 and /2):

```
N66046/2*  12/01/87 14:32:69
WK5M-1/1   12/01/87 16:25:01
WØXI/2     12/02/87 16:28:05
WDØEMR/1   12/02/87 16:32:09
```

In this illustration the number following the slant bar (/) indicates the port the station was heard on. Your callsign will usually be the last one in this list.

You can now see that by comparing the port on which your call appears in the JHEARD list to the port indicated for other stations, you can determine whether to CONNECT or XCONNECT to the station of your choice.

KA-Node Commands for Remote Use

When accessed by radio, the KA-Node has several commands which may be given to it. These commands are listed here for reference, with a description of each command. In these descriptions, the UPPER case characters of the command are required. LOWER case characters are optional. Those items listed within [] are optional and if used the UPPER/LOWER case convention listed above applies.

ABORT

This command will abort a KA-Node Connect or Xconnect request if it is the first data sent after the request. It must be spelled out entirely.

Bye

This command will cause the KA-Node to initiate a disconnect.

Connect callsign [Stay]

This command will cause the node to issue a connect request to "callsign" in the usual AX.25 mode. If the connect is successful, a link will be made to the next node or end-user station. The optional Stay feature provides a way to disconnect without losing the entire link. Normally when a disconnect occurs, whether issued by you or by the remote station, the connection to the KA-Node is also lost. Using the Stay option allows you to stay connected to the KA-Node when the remote station issues a disconnect.

Help

This command causes the KA-Node to send a brief help list, showing all commands available, with the options and a short description of each command.

Jheard [Short|Long]

This command will cause the KA-Node to transmit its MHEARD log. The returned list (without the short or long option) will look like this:

(KAM)		(KPC-4)	
LAWKAN/H*	01/09/88 08:25:15	LAWKAN/1*	01/09/88 08:25:15
N66046/V	01/10/88 00:03:10	N66046/2	01/10/88 00:03:10
WK5M-3/H	01/10/88 00:03:19	WK5M-3/1	01/10/88 00:03:19
WDØEMR/V	01/10/88 00:04:15	WDØEMR/2	01/10/88 00:04:15
(KPC-1,2,3 or 2400)			
LAWKAN	01/09/88 08:25:15		
N66046*	01/10/88 00:03:10		
WK5M-3	01/10/88 00:03:19		
WDØEMR	01/10/88 00:04:15		

The left column indicates the callsign (and SSID if appropriate) of a station heard. The character following the slant bar (/) shows the port on which the station was heard, if both ports are active. The asterisk indicates the station was heard via a digipeater. The center and right columns indicate date and time the station was last heard. The last call on the list will probably be your call. The above JHEARD lists show WDØEMR connecting to the KA-Node and requesting the node's JHEARD log.

The short (JHEARD S) version of this command would produce the following list:

(KAM)	(KPC-4)	(KPC-1,2,3 or 2400)
LAWKAN/H*	LAWKAN/1*	LAWKAN
N66046/V	N66046/2	N66046*
WK5M-3/H	WK5M-3/1	WK5M-3
WDØEMR/V	WDØEMR/2	WDØEMR

The long (JHEARD L) version of this command will also show the destination field and the digipeaters used. This list would look like:

(KAM)

```
LAWKAN/H* > WØXI      01/09/88 08:25:15
  VIA KSKU, TOP*, KSKU
N66046/V > BEACON    01/10/88 00:03:10
WK5M-3/H* > WDØEMR  01/10/88 00:03:19
  VIA WØXI, TOP*
WDØEMR/V > KC      01/10/88 00:04:15
  VIA KSTOP, KCMO
```

(KPC-4)

```
LAWKAN/1* > WØXI      01/09/88 08:25:15
  VIA KSKU, TOP*, KSKU
N66046/2 > BEACON    01/10/88 00:03:10
WK5M-3/1* > WDØEMR  01/10/88 00:03:19
  VIA WØXI, TOP*
WDØEMR/2 > KC      01/10/88 00:04:15
  VIA KSTOP, KCMO
```

(KPC-1,2,3 or 2400)

```
LAWKAN* > WØXI      01/09/88 08:25:15
  VIA KSKU, TOP*, KSKU
N66046 > BEACON    01/10/88 00:03:10
WK5M-3* > WDØEMR  01/10/88 00:03:19
  VIA WØXI, TOP*
WDØEMR > KC      01/10/88 00:04:15
  VIA KSTOP, KCMO
```

Nodes [Short!Long]

This command will cause the node to return a list of KA-Nodes it has heard, as well as NET/ROM or TheNet nodes. The format of the list is similar to that of the JHEARD list above.

Xconnect callsign (KAM and KPC-4 only)

This command will cause the node to issue a connect request to "callsign" (in the usual AX.25 format) on the opposite port of the KA-Node. Cross-connecting enables you to gain access, via the node, to another frequency.

Remote Access to Your KPC-3

Your Kantronics KPC-3 includes the ability to connect from a remote station and change the parameters in the KPC-3. This allows you to add or delete stations from the LLIST, change the size of the PBBS, change the MYCALL and so on. Extreme caution must be used when you are accessing your KPC-3 from a remote location. There is no built-in safeguard, and as such it is possible for you to change parameters such that the remote KPC-3 will no longer communicate.

In order to change parameters in a remote KPC-3, the RTEXT in the remote KPC-3 must be set to a text string that will be used as the password string. For instance, you might set your RTEXT to:

RTEXT This system belongs to WØABC in Lawrence, Kansas 66046

The remote KPC-3 must also have its MYREMOTE set to a unique callsign (i.e. WØABC-4, or XYZREM). If these two parameters are not set as indicated, remote access to the command set of this KPC-3 is not possible.

When these parameters are set, you can connect to the MYREMOTE callsign of the remote KPC-3. The MYCALL in your TNC must match the MYCALL of the remote KPC-3 (excluding SSID). In the example above, the MYCALL callsign of the KPC-3 I want to change is set to WØABC and the MYREMOTE is XYZREM, so the callsign of the connecting station must be WØABC-x (x = any SSID).

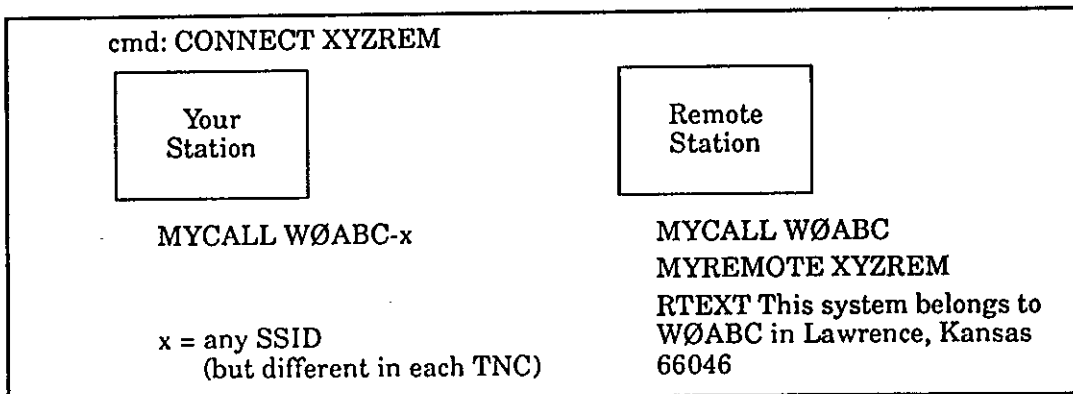

When the connection is made, the remote KPC-3 will send three lines of numbers. The numbers would look like:

```
5 20 43 36 18 3
37 1 44 14 28 19
48 26 8 52 22 1
```

You must then pick ONE of these lines and decode the password string. Let's say I choose to decode line 3 (48 26 8 52 22 1). Rewriting my RTEXT string to make this easier I would have:

```
          1          2          3          4          5
123456789012345678901234567890123456789012345678901234
This system belongs to WØABC in Lawrence, Kansas 66046
```

To decode the string, character 48 is "s", character 26 is "A", character 8 is "s", character 52 is "0", character 22 is "o", and character 1 is "T". I must send the following in response to my remote access attempt:

```
sAs0oT
```

Note that case is significant and spaces are considered valid characters. If you fail to properly decode the password, the KPC-3 will send three new lines of numbers. You will be given a maximum of three attempts to properly decode the password string. If you fail in three attempts, the KPC-3 will disconnect you and disable connects to the MYREMOTE for 15 minutes. Also, if you connect to the MYREMOTE and start the password sequence but then disconnect, the penalty timer is in effect for 15 minutes.

Be careful when using the remote access feature. You can change ANY command in the KPC-3 without restriction, but this can lead to problems. For instance, if you change the INTFACE command to KISS and then send a RESET command, the remote KPC-3 will be placed into the KISS mode and will completely quit talking to the radio! Also, if you connect to the MYREMOTE of a KPC-3 and then issue a command like CONNECT W1ABC, the remote KPC-3 will indeed connect to the station, but there will be no data sent to you from that connection. The connected data would be sent to the serial port of that remote KPC-3. We urge EXTREME caution when using the remote access! Note also that any command that causes a reset (i.e. NUMNODES, PBBS, MAXUSERS) will disconnect all current users (PBBS, NODE, and YOU).

One other minor limitation applies to receiving data from the remote KPC-3. When you give any command, the response is limited to 300 characters so some commands will not fully display their response. If you give the command DISPLAY, the full list will begin, but you will not receive the entire list because of the limitation on this buffer.

Kantronics Host Mode Operation

This section describes the Kantronics Host Mode. If you are using a "host" program (one that uses the Kantronics Host Mode) such as Host Master, many of the instructions you have seen in this Manual, and some of the Commands of the KPC-3 are not used in your program.

For instance, in the Host Mode, the KPC-3 does not send a cmd: prompt. Your host program will provide you with some means to give commands to the KPC-3. Also, the PACLEN parameter as set in the KPC-3 does not apply to Host Mode operation, your program will set the length of a transmitted packet. For a complete description of your host program, refer to the manual that comes with your software.

If you should need to use a "standard" terminal program after you have used a Host mode program, it is possible that your KPC-3 may still be in host mode when you first turn it on. If it is, you will not see the normal sign on message, but instead will see a message similar to "S00". The S00 is the message sent by the KPC-3 indicating it has been reset. If you see this type of message, you must first exit the Host Mode before you can start talking to the KPC-3 with your program. You must send three characters to the KPC-3 in order to exit the Host Mode. First, send a FEND character (ASCII code 192), then the letter q (upper or lower case is ok), and finally another FEND character. Your KPC-3 will then leave the Host Mode and send the usual Kantronics sign-on message.

This section is mainly intended for those who will be writing software programs that will interface to the Kantronics KPC-3 using the Host interface. For those using a Host Mode software program such as the Kantronics Host Master, it is not necessary to read this section, as this contains the technical operating details of the Host interface.

In order to place the KPC-3 into the Host Mode of operation, you must set the INTFACE command to HOST and perform a soft reset. The reset is accomplished by sending a RESET command or by changing the MAXUSERS value, PBBS value, or NUMNODES value. When the KPC-3 is operating in Host Mode, the only flow control available is through the RTS/CTS lines (hardware flow control).

Communication Format

Host computer to KPC-3

Communication from the host to the KPC-3 must occur in blocks. The block of data is delimited with a FEND character (\$C0) at the beginning and end. If the FEND character appears within the block as valid data, the host must replace this character with a special sequence, consisting of a FESC (\$DB) followed by a TFEND (\$DC). One other special sequence may be required in the event a FESC (\$DB) character is

required in the data field. This is accomplished by the special sequence of a FESC (\$DB) followed by a TFESC (\$DD). These special sequences are the same used in the KISS code, as implemented by Phil Karn, KA9Q.

After the opening FEND, the next character is the command byte and will indicate the type of command being given to the KPC-3. The permissible characters in the command byte are C, D, or Q.

A 'C' command byte indicates a command that the KPC-3 will interpret as if it were in the Command Mode. If the command byte is a 'D', the KPC-3 will consider the data as data to be transmitted on the specified port and stream. The letter 'Q' in the command byte will cause the KPC-3 to exit the Host Mode and return to Terminal Mode.

The next byte is the port byte. This byte must be used with every block of type 'D' to signify which port is to be used for transmission of the data. The KPC-3 only has one port, so the port byte must always be a 1. Type 'C' blocks must always specify this byte as a 1.

The fourth byte is the stream byte. This byte determines which stream (A-Z) the KPC-3 will use for the data. If the stream byte is 0 for a data packet (command byte D), the data will be sent out UNPROTO. For commands that do not involve a specific port or stream, the port byte is ignored and the stream byte should be set to 0. This is because the front panel LEDs (CON and STA) will automatically update to reflect the status of the port and stream that the last command or data was sent to.

A host program should therefore send a host frame to the KPC-3 every time it wishes to update the CON and STA lights on the front of the KPC-3. For instance, if you change the screen display to show data on stream C you should send FEND C1C FEND to the KPC-3. In addition, a specific command (such as TRIES) can now be sent to display the current RETRY count on this stream with the command FEND C1CTRIES FEND or with the command FEND C10TRIES FEND. In this case, since the stream byte is a 0, the TRIES command applies to the last non-zero stream byte and port that were addressed.

After these four header bytes, the structure of the block for a command is exactly the same as if you were entering the command from the Terminal Mode of the KPC-3. If entering data to be transmitted, simply place the data in the following bytes. Note that commands do not need a carriage return included in the data portion of the packet.

After the data or command, terminate the information from the host with a FEND (\$C0) character.

Byte 1	Byte 2	Byte 3	Byte 4	Variable Length	Last Byte
FEND	Command	Port	Stream	Data	FEND

KPC-3 to Host Computer

Communication from the KPC-3 to the host also occurs in blocks which are delimited at beginning and end with FEND characters (\$C0).

After the beginning FEND, the next character is the status byte. A status byte 'C' is a response to a command from the host with the command byte 'C'. A status byte of 'D' indicates that the data was received on a connected stream. 'M' in the status byte means that the data in this block is the result of the monitor commands.

A status byte of 'S' is a status message caused by a change in the link state. Such messages include the *** CONNECTED TO, *** DISCONNECTED, and FRMR sent. A special 'S' block of data consists of two FEND characters, the characters S00 and another FEND character. This indicates that the KPC-3 has performed a soft reset, and all existing connections (if any) are no longer valid. This is equivalent to the KPC-3 having just been turned on. A data block with the status byte 'R' is a *** CONNECT REQUEST. A block with status byte 'T' is the result of the TRACE command. Port and stream bytes (defined below) are valid for 'D' and 'S' blocks, but only the port byte is valid for 'T', 'M', and 'R' blocks.

The port byte follows the status byte, and will contain the port number the specific information is from. This will be a '1' for the KPC-3.

The stream byte follows the port byte. The stream byte will be 'A' - 'Z' for data on the connected streams. Data being sent to the host which is not connected data will have the stream byte set to '0'.

If the KPC-3 returns a 'C' status block with no data, this indicates that the command was accepted. This will occur on connect and disconnect commands.

A 'T' block from the host (TRACE information) is raw data, and not a hex dump of the received packet.

The KISS transparency (FESC, FEND, TFEND, and TFESC) described above is always applied to all blocks.

WEFAX Mode

General

Facsimile reception (WEFAX) is available with your KPC-3 since the weather facsimile broadcasts are using an 800 Hz FSK shift which is compatible with the Kantronics 1200 baud modem. In order to receive WEFAX, you must have a program for your computer which will receive 8 bit data from the KPC-3 and format it properly for display on your computer screen, or your printer. Kantronics has available three terminal programs which meet these requirements – MAXFAX for the Commodore 64 and 128 computers, SuperFax II for the PC, and WeFaxWorks for the Apple Macintosh computer.

Background: HF WEFAX Transmissions and Resolution

Many of the weather charts broadcast on HF as WEFAX are hand drawn synoptic maps, i.e. a summary of weather conditions, showing such things as atmospheric pressure and surface temperature over wide areas. Many of these maps show whole continents or oceans. These maps and charts are often produced by a particular weather service at their own HF radio station site. Two predominant stations are NAM, the Norfolk US Navy Fleet Weather Service station, and CFH, the Canadian Forces Halifax station.

Full size charts are eighteen (18) inches wide and vary in length from 10 to 18 inches. In past years, many charts were generated on a rotating drum at 60 scan lines per minute, but modern day charts are digitized (placed in computer storage) at the rate of 120 scan lines per minute on a flat-bed scanner. The scanner digitizes with a resolution of 96 lines or pixels per inch. So, the maximum resolution of a hand-drawn synoptic chart, when digitized, is nearly 1800 by 1800 pixels!

In addition to the temperature and pressure charts, redigitized satellite photos are sometimes transmitted over HF. The sources of most of these satellite weather photos are the National Oceanic and Atmospheric Administration (NOAA) operated weather satellites.

All WEFAX charts and pictures received on HF come from an HF ground station, not from any of the satellites. As mentioned above, many stations generate their own weather charts. Weather photos coming from the satellites are received first by a ground station, reformatted, and then relayed by telephone line to the HF transmission site for dissemination.

When the WEFAX maps and charts are transmitted on HF, some of the resolution is lost. This occurs because the FSK modulation scheme used by all manufacturers of HF WEFAX transmission equipment will not support the baud rate needed for full

horizontal resolution. The FSK format has been kept, however, to make today's equipment compatible with that produced earlier, and received-map resolution is acceptable.

Finding WEFAX Broadcasts

There are approximately 50 commercial and governmental WEFAX transmitters located in over 20 countries around the world. Most broadcast on HF (between 3 and 30 MHz). Many broadcast continually while others are on a sporadic schedule. You will nearly always find the following if ionospheric conditions permit:

LOCATION	FREQUENCIES (MHz)
Halifax, NS	4.275, 6.630, 9.890, 13.510
Norfolk, VA	8.080, 10.865, 16.410
San Diego, CA	8.646, 17.410
Mobile, AL	9.158
San Fran, CA	4.346, 8.682, 12.730, 17.151
Washington, DC	4.795, 10.185, 12.205, 14.672

In addition, many of the frequency guides for sale by various radio equipment suppliers list WEFAX station frequencies.

Tuning WEFAX Signals on HF

As mentioned earlier, WEFAX broadcasters use an 800 Hertz shift FSK format, using mark and space frequencies of 1500 and 2300 Hertz respectively. These tones, like voice broadcasts, are used to modulate the station RF carrier. You can tune these signals with your standard 1200 baud packet modem by tuning 1.7 KHz below the published station frequency in upper-sideband (USB). For example, with your HF transceiver or receiver set to USB, turn the dial until the frequency readout shows 8078.3 to receive NAM (the Norfolk US Navy Fleet Weather Service transmitting on 8080 KiloHertz).

Receiving WEFAX Transmissions

To receive WEFAX you need to connect an audio cable from your HF receiver to the audio input of your KPC-3. Be sure to read the documentation that comes with your WEFAX program to determine how to use it.

All of the programs available from Kantronics will issue the proper WEFAX command to start the reception of the image. The programs will work best at higher ABAUD rates, and we suggest 9600 for the PC and Macintosh based programs, and 1200 for the Commodore 64.

The WEFAX Command

To cause your KPC-3 to enter the WEFAX Mode, you use the WEFAX command.

WEFAX n

This command will cause the KPC-3 to sample the audio input at n samples per second. The value of n is determined by the number of pixels (dots) which can be displayed across one line of your terminal screen in the graphics mode. For instance, if the PC computer you use has 640 dots across the screen and the WEFAX station is transmitting 2 lines per second (120 per minute) you should use an n value of 1280. These values keep your KPC-3 in sync with the HF WEFAX transmitting station. If your WEFAX picture skews, adjust the KPC-3 clock by using the command DAYTWEAK. The ABAUD rate of the KPC-3 must be set to a value at least 5/4 the WEFAX n rate. This gives the terminal program time to display or store each pixel byte and to handle the extra start and stop bits added to the 8 pixel bits/byte (coming at xxxx baud rate). XFLOW may be used with WEFAX. To stop the sampling of WEFAX data and return to Command Mode, simply send a <Ctrl-C> to the KPC-3.

If you are using the Kantronics MAXFAX or SUPERFAX program with a PC compatible, you should set the ABAUD to 9600 in the KPC-3.

Suggestions for Writing a WEFAX Terminal Program

Preferences will vary for each WEFAX terminal program writer or user, but the following functions seem appropriate, at a minimum, for enjoyable operation.

WEFAX Program Functions:

1. Be able to display maps and charts on your computer screen as they are being received (real time).
2. Be able to store them to disk as they are being received or after you have taken a look.
3. Be able to print the displayed or stored maps or charts.
4. Be able to clear the screen or map storage area at any time.

What about hardware requirements? First of all, you'll have to have enough computer storage to handle the resolution you want. To save every pixel the HF station sends, you'll need up to 1800 lines, each line being your screen width in pixels (PC 640 pixels

or 80 bytes), or 135K bytes! However, your screen will not show this much. A PC or compatible in graphics mode can display 200 by 640 pixels, so we suggest that you write your program to save, for instance, 600 of 1800 lines at 640 pixels, or 48K bytes. Then, you'd be saving every third line received and sampling at an incoming bit rate of 1280 (640 by 2, hence the reason for WEFAX 1280). This will also improve the aspect ratio of the saved image, since the pixels on your PC screen are not square, and the picture is scanned at a resolution of 96 lines per inch. For the standard Macintosh, the normal screen is 512 pixels wide by 342 pixels high. The screen can therefore display more of a single picture at one time, but the horizontal resolution is slightly less than the PC.

Speed of program execution is important! Generally, interpretive BASIC will be too slow unless you want to limit reception to say one picture at a time. Most advanced BASICs will allow the allocation of up to 32K of storage in the I/O buffer. Then, as you are displaying incoming WEFAX lines, new data will be slowly accumulating in the buffer. If you don't have your program try to do too much, interpretive BASIC can just make it. Compiled BASIC, C, or assembly language programs, of course, are faster and more preferable.

Some considerations for the RS-232 port. When the KPC-3 is set in WEFAX Mode, it will send pixel bytes to your computer continually until you send it a <Ctrl-C> or turn it off! When in WEFAX Mode, the KPC-3 will do nothing else; it is simply too busy handling all that data. The bytes sent to your computer on the RS-232 receive data line include one start bit, eight pixel bits, and one stop bit. The most significant bit is the left-hand bit for your display. In effect then, if you specify WEFAX 1280, the KPC-3 will send you bytes every 8/1280 of a second or 160 bytes per second.

Now for printing. We recommend that you use a printer that is Epson graphics compatible with the PC or Commodore. If you write the program and your printer can handle 600+ pixels per line (this is about 60 dots per inch or dpi) and at least 32 lines per inch vertically, then it should be capable of printing WEFAX maps and charts. Note that six lines per inch of standard text is roughly equivalent to 72 lines per inch of graphics.

What about the structure of your program? We recommend that you include a simple terminal program that would be used to set the basic parameters of your KPC-3 (ABAUD, MAXUSERS, etc.). In addition, we recommend that you have a software loop that is interruptible by the arrival of pixel bytes. These bytes would then be stored and/or displayed in the interrupt routine. Once the bytes are processed, the interrupt routine would return to the main loop to await more pixel bytes from the KPC-3. If you use BASIC, BASICA, or compiled BASIC, then the ON COM statement is useful. Look in the manual under trapping.

KISS Mode

The KISS Mode allows the TNC to act as a modem and packet assembler/disassembler (PAD). The heart of the work to be done concerning what happens to data must reside in your computer in order to use this mode of operation. The KISS code as designed by Phil Karn is implemented to support higher level protocols for sharing computer resources in a network fashion.

The most popular program using the KISS Mode of operation is TCP/IP or Transport Control Protocol/Internet Protocol. This program will allow simultaneous file transfers using FTP (File Transfer Protocol), user conversations using TELNET, and a Simple Mail Transfer Protocol (SMTP). In addition, multi-connect capability is built into the package, with the data being displayed only for the current "session". You can relate a session to an I/O stream in the normal TNC operating mode.

In the KISS Mode, the TNC simply passes all received data to your computer, and the computer program is responsible for all processing of that data, including decisions concerning routing, digipeating, and other control decisions. The TNC converts the synchronous data being received from the radio link into asynchronous data to be passed to the computer over the serial port, and converts the asynchronous data from your computer into the synchronous format suitable for radio transmission. The TNC retains the responsibility for these functions, as well as determining proper timing for channel access.

In the KISS Mode, channel access is determined by two settings in your TNC – namely PERSIST and SLOTTIME. The algorithm used to determine whether or not to transmit using this method has been shown to be considerably more sophisticated than the DWAIT method used by most standard AX.25 packet stations. The result of using the persistence algorithm is increased throughput under most channel conditions. For our explanation of this algorithm, let's assume a PERSIST setting of 63 and a SLOTTIME setting of 10. This slottime setting corresponds to 100 milliseconds.

When the TNC detects that the channel is clear and available (no carrier is detected), it starts a timer (SLOTTIME). When the timer expires (100 ms in our case) the TNC generates a random number between 0 and 255. If the generated number is equal to or less than the PERSIST value, the TNC keys up the transmitter and sends the data packet. With our setting of 63 the odds of this occurring after the first slottime are about 1 in 4. (Actually the odds are PERSIST plus 1 divided by 256.) If the TNC generated random number is greater than PERSIST, the TNC restarts the timer and waits for the timer to expire again before generating a new random number. This is repeated until the TNC gains channel access and sends its packet of information.

By carefully examining what happens, we can see that making SLOTTIME smaller will cause the TNC to generate the random number more frequently, whereas raising the PERSIST value will give a better chance (improve the odds) of transmitting the data. Through careful choice of these values, it is possible to improve data throughput while at the same time permitting shared channel usage by other packet users.

Data received from the radio is converted into asynchronous format by the TNC and sent to your computer. The data actually sent over the serial port is formatted with special control information, allowing the computer to determine the type of data being received from the TNC.

Let's look at data from the TNC to the computer. First, all information flowing in this direction is data. No special messages are sent from the TNC to the computer in KISS Mode. The only data flowing in this direction is that received through the radio link. Every "frame" of data sent from the TNC will begin and end with a special FEND character. This character is the ASCII code \$C0 (hex) or 192 decimal. The second byte of the data will be the data type, and will always be a \$00. This means that the following information is data. If the data actually contains the FEND character (\$C0) it will be necessary to tell the computer that the \$C0 it receives is not the end of the frame, but simply is more data. This is accomplished by replacing the \$C0 character with a special sequence consisting of a FESC (\$DB) followed by a TFEND character (\$DC). One final special sequence which could be sent from the TNC to the computer is a FESC (\$DB) followed by TFESC (\$DD) This is translated into \$DB by the computer program.

Now, looking at data flowing in the other direction, that is from the computer to the TNC. There are five possible commands that you may need to issue to the TNC from the computer, and they basically concern setup parameters. These are commands needed to set TXDELAY, PERSISTENCE, SLOTTIME, and finally, a command to exit the KISS Mode of operation. The only other data which the computer may send to the TNC in KISS Mode is data which is to be transmitted over the radio (HDLC) channel. The data coming from the computer must also begin and end with the same FEND character as is used for data coming from the TNC. All special character sequences must also be used to send the FEND, and FESC characters as data.

Each of the commands is assigned a command type number as follows:

TYPE	FUNCTION
0	Data to be transmitted
1	TXDELAY – second byte contains txdelay in 10 ms increments
2	PERSISTENCE – second byte contains persistence value
3	SLOTTIME – second byte contains slot interval
255	Causes exit from KISS Mode

For example, if I want to set the TXDELAY in my KISS Mode TNC to 100 milliseconds, the computer would send the following bytes to the TNC:

C0 01 0A C0

and to send a data packet saying hello would be:

C0 00 68 65 6C 6C 6F C0

It is important to note that this data packet does not contain any addressing information, and therefore cannot be sent via AX.25 protocol. All of the addressing and formatting of the addresses must be done in the computer and sent as a data packet to the TNC.

One final sequence of value (particularly for PC compatible users) is the "Leave KISS Mode" sequence:

C0 FF C0

If for some reason, you have INTFACE KISS, when you turn the unit off and then on again you will be in KISS Mode. The only way to leave this would be to perform a hard reset, or use the TCP/IP command to leave KISS Mode, or to send the C0 FF C0 sequence from your keyboard. The PC compatibles offer this last opportunity by following this sequence:

- Press and HOLD the ALT key. Type the numbers 192 from the numeric KEYPAD. (Not the keyboard. Release the ALT key.)
- Press and HOLD the ALT key. Type the numbers 255 from the numeric KEYPAD. (Not the keyboard. Release the ALT key.)
- Press and HOLD the ALT key. Type the numbers 192 from the numeric KEYPAD. (Not the keyboard. Release the ALT key.)

Now if the terminal program you are using sent all those characters, you will be out of the KISS Mode. Remember to set the INTFACE command to something besides KISS if you do not want your TNC to be in KISS Mode when you turn the unit off and then back on.

Connecting the KPC-3 to Your Computer

KPC-3 to Computer Connection

The KPC-3 is connected to the serial data port of your computer and a terminal program must be loaded into your computer. The serial port provides a place for data to be sent to or received from the KPC-3. The terminal program is the software which runs in the computer, allowing it to communicate with the KPC-3. This is also sometimes called a communications program.

A few computer systems include a terminal program on the systems diskette or in the initial software package, usually named COMM, TERM, or a similar name which conveys the idea of communicating. Some computer systems require that a terminal program be obtained separately. In general, any program which allows telephone modem communications with the computer will be suitable for use with the KPC-3. A special program will be needed for the display of Wefax pictures.

There are generally four variables to be set in your terminal program. These are baud rate, parity, word length (also called data bits) and the number of stop bits. If your terminal program provides for these variables, use the following settings to talk to the KPC-3:

Baud rate: 300, 600, 1200, 1800, 2400, 4800 or 9600

Parity: None

Data bits: 8

Stop bits: 1

The 25-pin connector on the back panel of the KPC-3 is for connecting to the computer. When facing the back of the KPC-3 the connector on the right side is labeled COMPUTER.

Cable Wiring

The KPC-3 uses a standard RS-232 serial port with a DB-25 connector, configured as DCE equipment. This allows you to purchase a standard modem cable from any source and connect it directly to your RS-232 serial port on your computer.

For those who may want to make their own cable, the following chart shows what pins are used in the KPC-3 by name and number, and the corresponding pin to connect to for the most commonly used computer connectors. As a general rule, if you have a computer not covered here that has a serial data port, wire pins of the same name together.

Transmit Data (TXD), Receive Data (RXD) and Signal Ground (SG) must always be wired in order for the KPC-3 and the computer to exchange any data. Many terminal programs also require the use of hardware flow control from the KPC-3. For hardware flow control Request To Send (RTS) and Clear To Send (CTS) must also be wired. Check the documentation to your terminal program to see if any other wires are required.

Some programs want to see Data Set Ready (DSR) to know that the KPC-3 is there before operating. If this is the case wire both DSR and Data Terminal Ready (DTR). Or sometimes you can satisfy the program's needs by jumpering these two pins at the computer end of the cable. Data Carrier Detect (DCD) is needed by some BBS software to know that a connection has taken place. This would require wiring DCD. Some phone modem programs also want to see a connection before allowing you to even talk to the KPC-3. This case can usually be solved by jumpering DCD to DTR at the computer end of the cable. If your computer requires DSR and also DCD, it is perfectly acceptable to jumper all three pins (DTR, DSR, and DCD) together on the computer end of the cable.

Caution: Make sure the power to the transceivers, computer, and KPC-3 is OFF before connecting any cables.

Pin Name	KPC-3 (DCE)		RS-232 Computer (DTE)	
	DB-25 Pin No.	direction	DB-25	DB-9
FG*	1	====	1	N/A
TXD	2	<===	2	3
RXD	3	===>	3	2
SG*	7	====	7	5
RTS	4	<===	4	7
CTS	5	===>	5	8
DCD	8	===>	8	1
DSR	6	===>	6	6
DTR	20	<===	20	4

* FG (Frame Ground) and SG (Signal Ground) are tied together in the KPC-3.

DB-25 Connector

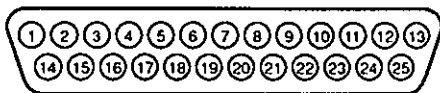

Male (Looking at Pins)

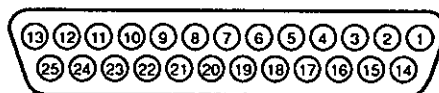

Female (Looking at Holes)

The functions of these lines are explained below.

DB-25 Pin 2 - TXD

Transmit Data. This line is the serial data from the terminal which is to be transmitted to the other station by the KPC-3. It is this line which is used for all communication from your terminal to the KPC-3, including commands.

DB-25 Pin 3 - RXD

Receive Data. This line is used by the KPC-3 to send the data it receives from the other station to your terminal. This line is also used to send KPC-3 messages to your terminal.

DB-25 Pin 7 and 1 - SG

Signal Ground. This line establishes the common reference potential for all circuits except Protective Ground.

DB-25 Pin 4 - RTS

Request To Send. This line tells the KPC-3 that the terminal is ready to receive data. An ON level tells the KPC-3 it may send data while an OFF level tells it to stop sending data. If the terminal for any reason is unable to accept data from the KPC-3, it will cause this line to change to an OFF state, providing that the terminal supports hardware flow control.

DB-25 Pin 5 - CTS

Clear To Send. This line is used by the KPC-3 to tell the terminal whether or not it may send data to the KPC-3. An ON level tells the terminal it may send data while an OFF level tells it to stop sending data. This pin is the complement to the RTS pin, implementing hardware flow control in the other direction.

DB-25 Pin 8 - DCD

Data Carrier Detect. This line is an output from the KPC-3 indicating connected status of the KPC-3. When a connection exists on the current stream, this line will be true.

DB-25 Pin 6 - DSR

Data Set Ready. Some terminal programs look at this pin to see that the KPC-3 is operating before allowing you to talk to the KPC-3. This pin is connected to the DTR pin as shipped from the factory, so connecting both DTR and DSR to your computer will provide an active DSR condition whenever the computer activates DTR. If required, you can configure the KPC-3 to automatically pull the DSR pin active by installing a 4.7 kohm resistor at R-48.

DB-25 Pin 20 - DTR

Data Terminal Ready. This pin is common with DSR in the KPC-3. The KPC-3 assumes the terminal is operating and does not require the terminal to pull this pin true. This pin may be isolated from DSR if desired by cutting the trace between the pads of J10. The trace is located on the bottom side of the PC board.

DB-25 Wiring Options

If desired, you can re-configure the DB-25 connector to allow some additional functions through this connector.

Applying Power through the DB-25 connector. If desired, you may apply DC power to the KPC-3 from Pin 25 of the DB-25 connector. To enable this, you must install two small wire jumpers on the PC board. One jumper should be installed at the J9 pads, between the center pad and the pad closest to the front of the KPC-3 (marked with the number 1). The second wire jumper will be installed at the J8 pads, between the center pad and the pad closest to the back of the KPC-3 (marked with the number 2).

Resetting the KPC-3 through the DB-25 connector. If desired, pin 25 of the DB-25 connector may be configured to allow you to perform a hard reset of the KPC-3 without opening the case. This is accomplished by installing two wire jumpers on the PC board. One jumper will be installed between the center pad and the pad closest to the front of the KPC-3 at J9 (marked with the number 1). The second jumper installs on the pads at J8, using the center pad and the pad closest to the front of the KPC-3 (marked with the number 1).

Hardware handshaking with DSR and DTR. It is possible that some computer cables may be wired to use the DTR and DSR pins for hardware handshaking instead of the RTS and CTS pins. If your cable is made this way, you can reconfigure the KPC-3 using the following steps. First, be sure no resistor is installed at R-48. Install a wire jumper between the pads at J12 next to the DB-25 connector. This connects the DSR line to the CTS line so either pin 5 or pin 6 can be used for output hardware handshaking. Next you must cut the trace between the pads at J10. The trace is located on the bottom side of the PC board. Finally, install a wire jumper between the pads at J11. This connects the DTR pin to the RTS pin, allowing either pin 4 or pin 20 to be used for input hardware handshaking.

Connecting Your Radios

The KPC-3 is attached to your transceiver via the radio connector on the back panel. (See the Getting Started manual for a diagram of the back panel.)

The KPC-3 is shipped with a DB-9 connector which must be wired to connect to your radio. The supplied mini-plug may be used for receive audio from your radio (speaker jack) or you may be able to pick up the receive audio through other connections on the radio. Refer to your radio manual when wiring this connector. Some samples are shown in the Getting Started Manual.

Some radios may require adjustment of the AFSK Output Levels or Equalization of the received signals. See the AFSK Output Level and Calibration/Equalization sections for information.

Caution: Check your transceiver manual to correctly wire the corresponding pins of the transceiver mic-jack.

DB-9 Radio Connector

Pins 1, 3, 5 and 6 must be connected to your radio. (See the Getting Started Manual for typical radio wiring diagrams.)

Pin 1 - AFSK Out. This line carries the AFSK tones generated by the KPC-3 to the Audio Input (microphone) line of your transceiver. If your transceiver provides a DC voltage on its microphone input, you must isolate this voltage from the KPC-3. This is normally true for hand-held radios. (See the Interfacing Hand-Held Radios section.)

Pin 2 - XCD. This line may be used to connect the squelch line from your transceiver if desired. This connection will not normally be required, nor used, unless operating on a shared voice channel. Normally the KPC-3 detects other signals by using its internal software to determine if data is present. If this pin is connected, a ground potential on this pin will tell the KPC-3 that a signal is present (even if there is no data) and therefore prevent the KPC-3 from transmitting until the signal is no longer present. (See the CD parameter in the Commands section.)

Pin 3 - Push-To-Talk. This line controls the PTT line in your transceiver, allowing the computer to switch the transceiver from/to transmit or receive. Connect directly to the PTT line of the mic-jack connector. (See the section on Interfacing Hand-Held Radios for special notes concerning this pin.)

Pins 4 and 5 - Audio Signal. This line is used for the receive audio from your radio. Connect the center conductor of the mini-plug to pin 5 and the ground of the mini-plug to pin 6. The mini plug can then be connected to your transceiver's external speaker jack. You may connect an external speaker to pin 4 of the KPC-3 to permit monitoring of the received signal if desired. Do not use a headphone output from the

transceiver. If you use an accessory or phone patch output, it may be necessary to provide a padding network to reduce amplitude of the signal being fed to the KPC-3. High level fixed outputs may have a tendency to "swamp" the KPC-3 input circuits. Fixed output signals in excess of 2 volts p-p should be padded.

Pin 6 - Ground/Shield. Connect the push-to-talk ground and AFSK shield to this line. Also connect the shield of the mini-plug cable (if used) to this pin. With some transceivers which do not reference PTT and audio shielding to a common ground, it may be necessary to leave the AFSK shield (braided wire) disconnected. Note: All KPC-3 grounds are common.

Pin 7 - Not connected (See Optional connections below)

Pin 8 - Ground. Same as pin 6.

Pin 9 - Ground. Same as pin 6.

Optional connections to DB-9 Radio port of the KPC-3

Pin 7 of the DB-9 connector may be configured to allow you to apply power to the KPC-3 or to perform a hard reset on your KPC-3 without opening the case.

To power the KPC-3 from Pin 7 of the DB-9 connector, you must install two wire jumpers on the PC board. Install one jumper at the pads marked J8, between the center pad and the pad closest to the back of the KPC-3 (marked 2). The second jumper is installed on the pads at J9 between the center pad and the pad closest to the back of the unit (marked 2).

To perform a hard reset from Pin 7 of the DB-9 connector, you must install two wire jumpers on the PC board. Install one jumper at the pads marked J8, between the center pad and the pad closest to the front of the KPC-3 (marked 1). The second jumper is installed on the pads at J9 between the center pad and the pad closest to the back of the unit (marked 2). Applying a ground to pin 7 when you power up the KPC-3 will then perform a hard reset.

AFSK Output Level (Jumper J3)

AFSK – Audio Frequency Shift Keying

Jumper J3 selects the range of AFSK (audio) output available from the KPC-3. Best performance is normally achieved by adjusting the AFSK level to provide approximately 3.5 KHz deviation on your FM radio.

When installed on only one pin (factory setting) the audio output may be adjusted between approximately 2 millivolts p-p up to 60 millivolts p-p with the potentiometer (R13).

When Jumper J3 is placed on both pins, the output is continuously adjustable from 140 mv to approximately 4 volts p-p with R13.

Refer to the Assembly and Disassembly section for information on obtaining access to the interior of the TNC.

Interfacing Hand-Held Radios

Many transceivers, especially most hand-held models, obtain Push-To-Talk keying by completing a circuit between the mic input and PTT ground. A direct PTT input to the mic input line of units with this type electret condenser microphone is not usable without some type of isolation.

If you plan to operate with a hand-held transceiver, the KPC-3 has incorporated an isolation circuit which is available by positioning jumper J2 on the center post and the left post (labeled HT) as you face the front of the KPC-3. Should you later use a different type radio, this change may need to be reconfigured by placing the J2 jumper on the center post and the right post. Most other radios of current manufacture will not require any modification of the KPC-3.

You may also interface to a hand-held without performing this modification by incorporating the same type of circuitry in the cable from your KPC-3 to your hand-held. Ground return and speaker audio are both supplied through the external speaker jack of your hand-held.

ICOM HT radios key the PTT by providing a low impedance path from the mic input to ground. To accomplish this, simply install a resistor (approximately 3.9K seems to be a good value) in series with the PTT wire from the KPC-3, and connect this to the mic input along with the AFSK line.

2AT Style Hand-Held Radios

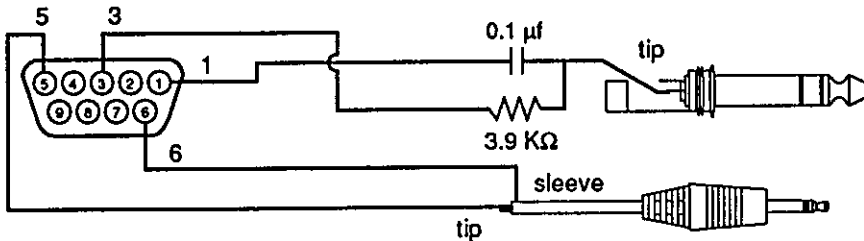

W2A Style Hand-Held Radios

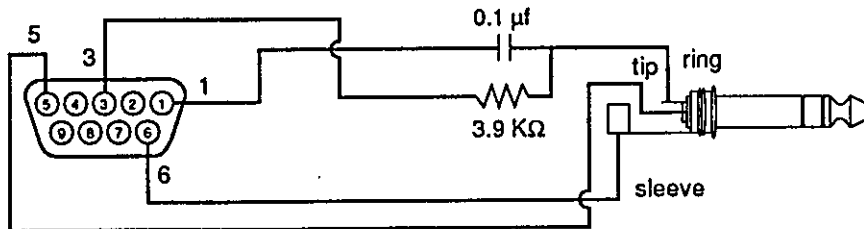

YAESU radios are similar but use a mono plug and a different resistor.

Yaesu Hand-Held Radios

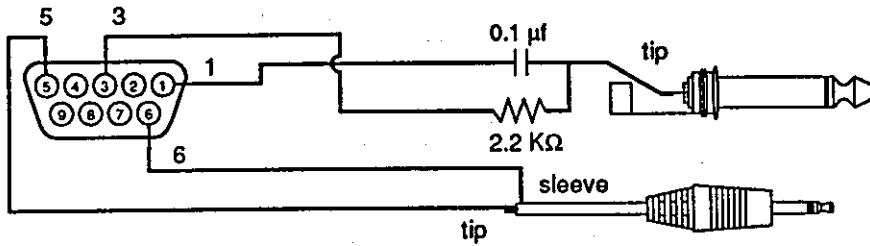

Most KENWOOD HT radios key the PTT line by connecting the sleeve of the mic connector to the sleeve of the earpiece connector. This means that you will not need a resistor in the PTT wire from the KPC-3, simply connect the PTT wire to the sleeve of the mic connector. Another point to watch – most of the KENWOOD HTs (2600 and later) use a three pin mic connector. The AFSK from the KPC-3 should therefore connect to the RING and not the TIP of the mic connector.

TR-2600 and later Hand-Held Radios

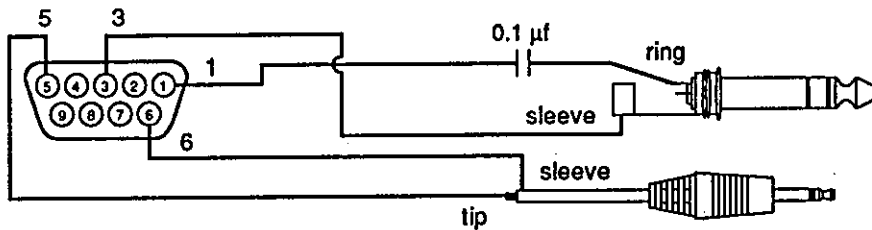

TR-2500 Hand-Held Radios

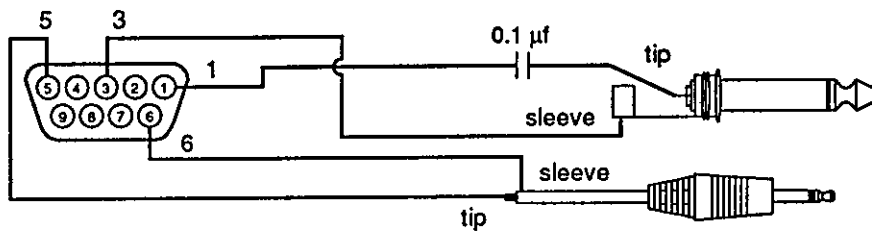

In Case of Difficulty

Your Kantronics KPC-3 is manufactured to very stringent quality standards. If you have followed the installation procedures outlined in this manual, it is highly unlikely that you will encounter a failure. If you do have difficulty, use the procedures described in this section to assist in isolating and correcting the problem.

TNC Does Not "Sign-On" to Computer

1. Carefully recheck cabling between your computer serial port and the TNC.
2. Check carefully to insure that the Transmit Data, Receive Data, and Ground leads are connected to the proper pins.
3. If you have made a 5 wire connection to the computer serial port, change to a 3 wire connection.
4. Check your terminal program to be certain it is booted with the correct communications parameters (serial port, baud rate, parity).
6. Try a "Hard Reset" using the Hard Reset jumper. (Operate your terminal program at 1200 baud when performing a hard reset.)

You Are Unable to Make a "Connect"

1. Issue a connect request and observe the XMIT LED. If the XMIT LED illuminates, check to insure that the radio is connected to the radio port. If the XMIT LED does not illuminate, check to be sure the XMITOK command is turned ON.
2. Observe the radio to determine if it is being switched to the "Transmit" condition. If not, recheck wiring between the TNC radio port, PTT pin, and ground on the microphone jack.
3. Set the CD command to INTERNAL and turn the radio squelch control to "OFF" and see if the RCV LED illuminates on the packet controller. If it does not light, recheck the audio connection between your transceiver and the TNC.
4. If possible, monitor your transmitted signal with another radio. If the transmitter is keying to "Transmit" but weak or no audio is monitored, increase AFSK output as necessary using R-13. (See the AFSK Output Level section.)

Cannot Transmit

1. Check the XMITOK command – it must be ON to allow transmitting.

Cannot Return to Command Mode

1. The single most common cause of this is that the STOP character (and usually XOFF) have been inadvertently set to the same as the COMMAND character. This is usually caused by the use of the dollar sign (\$) as a streamswitch. If you use the \$, be aware that you cannot enter hex values without PASSing the dollar sign. Symptoms for this usually are that you can talk to the TNC fine in Command Mode, you can usually talk to others on the air, but you just can't get back to Command Mode. With most PC terminal programs, pressing Ctrl-C will display the heart character, but you still don't get the cmd: prompt.

Assembly and Disassembly of the KPC-3

Should you require access to the KPC-3 to reposition jumpers or for other purposes, disassemble as follows:

1. Turn off power to your KPC-3 and remove all cables from the unit.
2. Using a small phillips screwdriver, remove the two (2) case screws (located on each side of the case) completely.
3. Remove the top cover from the unit.

NOTE: In most cases, no further disassembly of the unit is necessary. Only if you need to change a wire jumper or solder connections to the PC board should you continue with disassembly of your KPC-3.

4. Remove the four (4) hex nuts on the rear panel that secure the DB-9 and DB-25 connectors to the case.
5. Remove the two (2) screws securing the front panel to the case.
6. Remove the front panel.
7. Observe proper static protection precautions and gently lift the front edge of the PC board to clear the front of the case.
8. Pull the PC board forward to remove the PC board from the case.

To reassemble, reverse the procedure above.

Hard Reset

The hard reset process is provided to re-initialize the KPC-3 to its default values. This process may become necessary should operational problems be encountered or when upgrading your firmware to a new version. The readout specified in step 5 below will be legible only if your terminal baud rate is 1200. At other terminal baud rates, a reset will occur. However, no display readout will be observed. This procedure is performed as follows:

- 1) Open the KPC-3 by removing the two (2) case screws on the sides of the unit and lifting the cover.
- 2) Locate the Hard Reset jumper (J7). Jumpers are appropriately labeled on the PC board. Refer to the parts location diagram for help in locating them.
- 3) Place the jumper on both pins.
- 4) Apply power to the KPC-3.
- 5) Observe on the computer display (your terminal program must be set at 1200 baud):

```
CHECKSUM OK
RAM OK xxxK BYTES
CLOCK NOT PRESENT
REPLACE TEST JUMPER
```

- 6) Turn power off.
- 7) Return jumper J7 to the normal position (one pin only).
- 8) Reassemble the KPC-3 and return to operation.

Calibration/Equalization

The CALIBRATE command is used to assist the TNC operator in determining the need for equalization of a received signal. Since this feature is unique to Kantronics TNCs, two stations using Kantronics TNCs are necessary to utilize this command.

Once the CALIBRATE command is given, three options will appear on the terminal screen:

Calibrate Mode Press M,R,S,T, or X

Pressing M will transmit a constant Mark.

Pressing R will measure a square wave received.

Pressing S will transmit a constant Space.

Pressing T will transmit a square wave (space/mark) at the selected tones until a key is pressed.

Pressing X will return the TNC to the Command Mode.

One station should be used to transmit the square wave, while the receiving station should measure and compare the space/mark square wave. The transmitting station should set the microphone level in the mid range.

Once the receiving TNC is placed in the CALIBRATE receive mode, two numbers will appear on the screen. The TNC is measuring the space/mark square wave generated by the transmitting station. For the best calibration of the receiving transceiver, set the radio tone controls so that the two given values are as close to equal as possible.

In most instances when the ratio of the numbers is within a 40/60 or 60/40 range, the packet station will function normally. A larger disparity in the tones may cause additional retries during packet operation. This ratio may be determined by the following formula:

$$(N1 * 100) / (N1 + N2)$$

where N1 is the number to the left of the displayed slash, and N2 is to the right of the slash. For instance, if the TNC displays 1400/1800, the ratio can be determined by:

$$(1400 * 100) / (1400 + 1800) \text{ or } 140000/3200 = 44$$

Since the total is 100, the ratio is then 44/56 and is within the 40/60 criteria.

If the ratio of the numbers exceeds 60/40, you should reset the internal Equalization jumper (J1) for equalization.

Watch Dog Timer

The KPC-3 has a built-in Watchdog Timer which will activate anytime it detects that the transceiver has been continuously keyed in transmit for more than approximately 2-1/2 minutes. This protects your radio against the possibility of a failure in the TNC keeping your transmitter turned on.

To disable the watchdog timer, simply install a wire jumper connecting the two pads located at J4 on the PC board.

Jumper Definitions

The KPC-3 has several jumpers on the PC board which enable many options and functions. The purpose of each jumper is described below. Some of these will already have a header installed and will be indicated in the description.

J1 - Equalization jumper (2 pin header): This jumper provides selection of proper equalization. When installed on both pins, no equalization is used, and when the pins are not connected (installed on one pin only) equalization is used.

J2 - HT modification (3 pin header): When the jumper is placed on the center post and the post on the right (facing the front of the unit) the KPC-3 uses normal PTT circuitry. When placed on the center post and the left post (marked HT), the PTT circuitry is modified for use with many hand-held radios. In this configuration, PTT is obtained through the AFSK line and is normally used for ICOM and YAESU hand-held radios.

J3 - AFSK level (2 pin header): When the jumper is placed on both posts, the AFSK level may be adjusted between 140 millivolts and 4 volts peak-to-peak using R-13. When placed on only one post, the output level may be adjusted between 2 millivolts and 60 millivolts peak-to-peak.

J4 - Watchdog Timer: The pads on the PC board at J4 are not normally connected to each other, enabling the watchdog timer circuit. To disable the watchdog timer, install a wire jumper between the 2 pads.

J5 - Real-time Clock: As shipped from the factory, a small wire jumper is installed between the two pads on the PC board at J5. If you purchase and install the optional Real-Time-Clock module (Dallas Semiconductor DS1215) you must cut the jumper between these pads and also install the clock crystal at X3.

J6 - 512K Ram Expansion: As shipped from the factory a small PC board trace is connected between the center pad and the pad closest to the front of the KPC-3 (position 1), on the bottom side of the PC board. This allows the use of the standard 32K static RAM, or optionally you may install the 128K static RAM (P/N 628128). If you want to install the 512K RAM, you must cut the board trace and install a new jumper between the center pad and the pad closest to the back of the KPC-3 (position 2).

J7 - Hard Reset (2 pin header): When the jumper is placed on both posts of this header and the power is applied to the KPC-3, a hard reset is performed, returning the KPC-3 to factory defaults and erasing all RAM contents. Normal operation requires that this jumper be installed on only one post.

J8 - External signal select: J8 consists of three pads on the PC board. It allows either DC power or an external reset to be applied through one of the two rear-panel connectors. Placing a wire jumper in position 1 (between the center pad and the pad closest to the front of the KPC-3) configures the KPC-3 to receive a hard reset through

the rear panel connector. If a wire jumper is installed in position 2 (between the center pad and the pad closest to the rear of the KPC-3) the rear panel connector can be used to supply DC power to the KPC-3.

J9 - Connector select for external signal: J9 consists of three pads on the PC board and determines which connector (DB-25 or DB-9) will be used to supply the external signal selected by J8. When a wire jumper is installed in position 1 (center pad and the pad closest to the front of the unit) the external signal will be supplied by pin 25 of the DB-25 connector. When a wire jumper is installed in position 2 (between the center pad and the pad closest to the back of the KPC-3), the external signal comes from pin 7 of the DB-9 connector.

J10 - DTR/DSR: The two pads at J10 are normally connected together by a small board trace on the bottom of the PC board. This connects the DTR line (from the computer) back to the DSR line (to the computer) in a loopback configuration. Some computer software requires this wiring in order to operate properly. Those software programs that do not require this connection will simply ignore it.

J11 - DTR/RTS: This jumper allows you to reconfigure your KPC-3 to use the DTR pin instead of the RTS pin for hardware handshaking. See the section on connecting your computer for further information.

J12 - DSR/CTS: This jumper allows you to reconfigure your KPC-3 to use the DSR pin instead of the CTS pin for hardware handshaking. See the section on connecting your computer for further information.

Options for the KPC-3

Installing a 9 volt battery in the KPC-3

The KPC-3 has been designed with space inside the case to install a 9-volt transistor radio battery. This can be used to operate the KPC-3 without connecting it to an external source of power. It is NOT required for any other purpose, as the internal Lithium battery will back up the RAM contents (including the mailbox) and will also keep the real-time clock module (if installed) operating. If you install the battery option, it will automatically be disconnected when you connect an external power source through the rear panel.

You must obtain a 9-volt battery connector from any vendor such as Radio Shack (cat # 270-325 or equivalent). Next to the power jack on the PC board are two pads marked "BATT". Solder the black (negative) lead from the battery connector to the PC board at the pad marked -. Solder the red (positive) lead to the PC board at the pad marked +. Connect a standard 9-volt transistor radio battery to the connector and place the battery in the case, locating it in the cut-out of the PC board. Tuck the wires into the case and be careful when reassembling the unit so you don't pinch the battery wires in the case.

Caution: If the battery connector is installed and you do not have a battery installed in the unit, you should insulate the battery clip to prevent it from touching any components in the KPC-3.

Expanding the RAM in the KPC-3

It is possible to expand the RAM in the KPC-3 from the standard 32K bytes to a maximum of 512K bytes. There are two possibilities.

If you wish to expand the RAM to 128K, simply remove the existing 32K static RAM from socket U9 and install a 128K x 8 static RAM (P/N 628128 or equivalent) in its place. Be sure the notch indicating pin 1 of the RAM chip is pointed toward the left edge (facing the front) of the KPC-3. Notice also that the 32K RAM chip has its pin 1 pointing left, but it seats as far right in the socket as possible.

Expanding the RAM to 512K bytes requires that you cut the PC board trace on the bottom side of the PC board located at jumper J6. The trace currently is between the center pad and the pad closest to the front of the KPC-3 (position 1). You must then install a new wire jumper between the center pad and the pad closest to the back of the KPC-3 (position 2). Remove the existing 32K RAM from U9 and install a 512K x 8 static RAM.

Installing the optional Real-Time Clock module

The real time clock option consists of two components: a Dallas Semiconductors DS1215 clock module, and a 32.768 KHz crystal. To install this option, carefully solder the crystal to the PC board at X3. Install the DS1215 in the socket at U11 with pin 1 (indicated by a notch or dot on the IC) closest to the right edge of the KPC-3 when facing the front of the unit. Next, cut the factory installed wire jumper at J5.

When the optional real-time clock is installed, the KPC-3 firmware will read the real-time clock only when the unit is first powered up.

Replacing the Lithium Battery

To replace the internal Lithium battery, remove the cover from your KPC-3 and carefully slip the battery out of the battery holder. You may need to use an insulated tool to assist in removal of the battery. When installing a replacement battery (CR 2032 or equivalent), be sure you have the positive terminal against the top clip of the battery holder. See the precautions at the front of this manual concerning disposal of lithium batteries.

NOTE: When you remove the lithium battery from your KPC-3, all stored parameters will be lost and the unit will revert to the factory default parameters.

Low Power Operation

Your KPC-3 is capable of very low power operation. In order to achieve the lowest power consumption possible, you must turn the front panel LEDs off with the command **LEDS OFF**. Also, the modem must be set for **INTERNAL** carrier detection with the command **CD INTERNAL**. In this configuration, the KPC-3 will draw less than 15 ma when no signal is being received. Note, however, that the actual current drain may vary slightly depending on the RS-232 connections to the unit. Some computers will cause the current drain to be slightly higher than other computers.

If you use software carrier detection (**CD SOFTWARE**) the current drain will be higher in the "idle" mode since the processor is actively looking for data even when no signal is present.

Specifications

Size: 0.8" x 5.2" x 5.2" (21 mm x 133 mm x 133 mm)

Weight: 11 oz (0.32 kg)

Power Requirements: 6 VDC to 25 VDC < 40 ma

Power Plug Polarity: Center pin positive

Watch Dog Timer: Approximately 2-1/2 minutes

External Carrier Detect (XCD): Pulldown to ground

External Reset: Pulldown to ground

PTT Output: Open drain, +50 VDC max, 200 ma max

Audio Output:

Continuously adjustable: LO: 2 mv - 60 mv p-p HI: 140 mv - 4 v p-p

Output Impedance (ac coupled): 600 ohm

Modulation: 1200 bps FSK, full duplex

Bell 202 (1200 Hz / 2200 Hz)

CCITT V.23 (1300 Hz / 2100 Hz) – cut R23

Audio Input:

Input Sensitivity: 5 mv p-p (no equalization)

Dynamic Range: 70 dB

Input Impedance (unbalanced): 600 ohm

Max Input Voltage: +/-12 VDC; 35 V p-p sinusoidal

Modes of Operation: Packet, WeFax, KISS, Host

Other Features: PBBS, KA-NODE, Remote Access

Display Listings

cmd:disp a

ABAUD (see note)
AUTOLF ON
BKONDEL ON
CRSUP OFF
ECHO ON
ESCAPE OFF
FLOW ON
INTFACE TERMINAL
LCOK ON
LCSTREAM ON
LFSUP OFF
NUCR 0
NULF 0
PARITY (see note)
RING ON
SCREENL 0
TRFLOW OFF
TXFLOW OFF
XFLOW ON

Note: ABAUD and PARITY will be set automatically to proper value when you press *.

cmd:disp i

BEACON EVERY 0
BTEXT
CMSG OFF
CTEXT
CWID EVERY 0
HID ON
MYCALL (see note)
MYALIAS
MYNODE (see note)
MYPBBS (see note)
MYREMOTE
NDWILD OFF
NTEXT
RTEXT
UNPROTO CQ

Note:

MYCALL set by your entry to
ENTER YOUR CALLSIGN=> prompt

MYNODE set to your MYCALL-7

MYPBBS set to your MYCALL-1

cmd:disp c

CANLINE \$18 (CTRL-X)
CANPAC \$19 (CTRL-Y)
COMMAND \$03 (CTRL-C)
DELETE \$08 (CTRL-H)
PASS \$16 (CTRL-V)
REDISPLA \$12 (CTRL-R)
SENDPAC \$0D (CTRL-M)
START \$11 (CTRL-Q)
STOP \$13 (CTRL-S)
STREAMSW \$7C (1)
STREAMCA OFF
STREAMEV OFF
XOFF \$13 (CTRL-S)
XON \$11 (CTRL-Q)

cmd:disp l

8BITCONV ON
AX25L2V2 ON
A Link state is: DISCONNECTED
CD INTERNAL
CONLIST OFF
CONMODE CONVERS
CONOK ON
CR ON
DBLDISC OFF
DIGIPEAT ON
FULLDUP OFF
HBAUD 1200
LFADD OFF
MAXFRAME 4
MAXUSERS 10
NEWMODE ON
NOMODE OFF
NUMNODES 0
PACLEN 128
PASSALL OFF
RELINK OFF
RETRY 10
STATSHRT ON
SWP 17,17,108
USERS 1
XMITOK ON

cmd:disp m

BUDLIST OFF
BUDCALLS NONE
CSTAMP OFF
DAYUSA ON
FILTER OFF
HEADERLN ON
LLIST OFF
MONITOR ON

MALL ON
MBEACON ON
MCON OFF
MCOM OFF
MRESP OFF
MRPT ON
MSTAMP OFF
PID OFF
SUPLIST OFF
SUPCALLS NONE
TRACE OFF

cmd:disp p

PBBS 5
PBHEADER ON
PBLO OLD FIXED
PBPERSON OFF
PTEXT

cmd:disp t

AXDELAY 0
AXHANG 0
CHECK 0
CMDTIME 1
CPACTIME OFF
DAYTWEAK 8
DWAIT 0
FRACK 4
KNTIMER 15
PACTIME AFTER 10
PERSIST 63
RESPTIME 5
RNRTIME 0
SLOTTIME 10
TXDELAY 30

Messages From the KPC-3

*****(callsign) busy**

The packet station you were attempting to connect to (callsign) is unable to accept connects.

Already connected on stream

You are attempting to connect to someone you are already connected to on another stream. The STATUS command will show you who you are connected to and on what stream.

BBS BUSY

You have attempted to connect to your own PBBS, but the BBS is in use by another station.

CALIBRATE MODE: PRESS M,R,S,T, OR X

This message appears on your screen when you enter the Calibrate Mode, and prompts you to press M to generate a MARK tone, R to receive a Kantronics Calibrate signal, S to generate a SPACE tone, T to transmit a Kantronics Calibrate signal, or X to return to the Command Mode.

Can't DISCONNECT

You are not connected on this stream so therefore cannot disconnect. This message will be followed by the stream and a "Link state is:" message, described later in this section.

Can't RECONNECT

You have attempted to reconnect to a station (by issuing a CONNECT command) but the callsign you entered is not the same as the station you are already connected to. You may only reconnect to the station you are connected to on this stream.

CHECKSUM ERROR

This message indicates that the Kantronics firmware in your KPC-3 is damaged. You may see this message when performing a hard reset, or any time a soft reset is performed (including initial power up).

CHECKSUM OK

When performing a hard reset, this message indicates that the Kantronics firmware Eprom has passed the internal checksum test.

cmd:

This is the Command Mode's prompt for input. Any characters entered after the TNC prints "cmd:" will be used as command input and not packet data.

Command not available in NEWUSER mode

This message indicates that you have attempted to change one of the commands in the KPC-3, but that command is not currently available to you. This occurs when the INTFACE command is set to NEWUSER. To enable all commands, set INTFACE TERMINAL.

*** connect request:

A remote packet station has attempted to connect to you, but there is not a valid stream available for the connection. The remote station will be sent a busy message, <DM> packet. See the USERS and MAXUSERS commands for setting more streams and allowing more connects at one time if desired. Also be sure CONOK is ON.

*** CONNECTED to CALL1 [VIA call2....call9]

A packet connection has taken place. This can happen by you issuing a connect request or a connect request coming in from a remote station. CALL1 will be the callsign entered in the remote stations MYCALL and if a path was used it will be shown.

*** DISCONNECTED

The packet connection no longer exists.

EH?

This is the TNC's generalized "I don't understand" message. A dollar sign (\$) is used to point to the offending character. It will also appear if a required input item is missing, e.g.:

```
C KV7B V
      $
EH?
```

In this example, the required callsign after the VIA option is missing. Most commands that receive an EH? error are ignored. In a few cases, part of the command may be accepted and acted upon, as described under the message "Input ignored".

ENTER YOUR CALLSIGN=>

Type in your callsign. The KPC-3 needs to know who you are to properly implement its protocol. Your callsign will be placed in the MYCALL parameter and used to generate the MYNODE and MYPBBS callsigns.

xxxx FREE BYTES

This message indicated how many additional characters may be entered into the KPC-3 packet buffer before the buffer is full.

*****FRMR received:**

A frame reject packet has been received for an unknown reason. The information field of this packet will display in hexadecimal value. This display may be useful in determining why the receiving station rejected your packet.

*****FRMR sent:**

Frame reject packet has been sent due to a detected error in protocol. Three bytes (6 hexadecimal characters) are displayed to assist in determining the reason for the reject.

Input ignored

Since the KPC-3 command interpreter was kept small and simple, it will sometimes change parameters before it completes parsing some of the more involved commands. In some cases, options at the beginning of the command will have been acted on before a syntax error near the end of the line is reached. When this occurs, "Input ignored" is used to show what part of the line was ignored. The dollar sign points to the boundary: characters to the left were used; the character pointed to and those to the right were not, i.e., the line was parsed as if a <CR> was entered at the \$.

Example:

```
BUDCalls QST,WB9FLW K9NG
                        $
```

Input ignored

Because the comma is missing, the command is interpreted as if it were BUDCALLS QST,WB9FLW; the K9NG is ignored.

INVALID STREAM

The stream you have tried to change to is not valid. Stream designators must be letters A - Z. MAXUSERS sets the upper limit on valid streams. The setting of LCSTREAM determines if lower-case characters are permitted when switching streams.

KANTRONICS PACKET CONTROLLER III VERSION 5.0

**(C) COPYRIGHT 1988-1992 BY KANTRONICS INC. ALL RIGHTS RESERVED.
DUPLICATION PROHIBITED WITHOUT PERMISSION OF KANTRONICS.**

This message appears when the KPC-3 is first turned on and after any soft reset, including changing the NUMNODES, PBBS, MAXUSERS or MYREMOTE commands, or issuing the RESET command.

Link state is:

This message is output in response to the **CONNECT** and **DISCONNECT** commands if the state of the link does not permit the requested action. It is prefaced by "Can't **CONNECT**" or "Can't **DISCONNECT**" as appropriate and will be followed by the current link state. A **CONNECT** command with no options will display the current link state.

Current link states are:

Both devices busy

Both TNCs involved in the connection are unable to accept any more data.

CONNECTED to (callsign v path)

Your TNC is currently connected to the indicated station, using the path given.

CONNECT in progress

Your TNC is attempting to establish a connection.

Device busy

Your TNC is unable to accept any more data from the remote station at this time.

DISC in progress

Your TNC is attempting to disconnect from another station.

DISCONNECTED

No connection exists on the current stream.

FRMR in progress

Your TNC has detected an error in the protocol. This is normally caused by two TNCs using the same callsign, resulting in both of them trying to respond to the same message.

Remote device busy

The remote TNC is unable to receive any more data from the radio at this time.

Waiting ACK and device busy

Your TNC has sent a packet to another station and is waiting for the acknowledgment, but your TNC is not able to accept any data from the radio at this time.

Waiting ACK and remote busy

Your TNC has sent a packet to another station and is waiting for the acknowledgment, and the remote TNC is not able to accept any data from the radio at this time.

Waiting ACK and both devices busy

Your TNC has sent a packet to another station and is waiting for the acknowledgment, but neither your TNC nor the other station's TNC is able to accept any data from the radio at this time.

Waiting acknowledgment

You have sent a packet of data to another station, and your TNC is waiting for the acknowledgment.

MESSAGES WOULD BE LOST

This message indicates that you have attempted to set the PBBS size too small to hold all of the existing messages in the mailbox. The size is not changed, and therefore no messages are lost. If you want to make the mailbox smaller, you must first delete some of the messages or set the PBBS to 0, erasing all of the messages, then set the new PBBS size.

NO KNOWN NODES

An NDHEARD list has been requested and the KA-Node does not know of any other nodes.

NOT ENOUGH RAM

This message indicates that you have attempted to set the NUMNODES, MAXUSERS, or PBBS to a value which requires more RAM memory than is currently available. It may also occur if you try to enable the MYREMOTE and there isn't enough memory left.

Not while connected

Some parameters cannot be changed if the KPC-3 is connected to another station. This message is printed if an attempt is made.

PBBS MESSAGE BUFFER NOT VALID

When you turn on the KPC-3 a check is made of the pointers relating to the PBBS. It appears that one or more of these pointers may not be correct.

PRESS (*) TO SET BAUD RATE

You need to press the asterisk (*) key on your keyboard within two seconds of seeing this message. The KPC-3's autobaud routine will then detect what baud rate your computer is talking so the two devices can communicate.

RAM OK xxxK BYTES

This message appears when a hard reset is performed and indicates that the KPC-3 has tested the installed RAM and has found no problems. It also reports the amount of RAM installed in your KPC-3.

RAM ERROR xxxK BYTES

If this message appears when you perform a hard reset, the KPC-3 has detected a problem with the installed RAM, and reports how much of the RAM it is able to use.

*****retry count exceeded**

***** DISCONNECTED**

The number of tries set by the **RETRY** command has been exceeded. Therefore the connection has been broken.

S00

This message from the KPC-3 indicates that it is in the **HOST** mode of operation, and has just performed a reset. To exit the Host mode, you must send three characters to the KPC-3 from your keyboard. See the Host mode section of the manual for details.

Value out of range

If the syntax of the command is legal, but the value specified is too large or too small for this command, the value out of range message is returned. A \$ is used to point to the bad value.

was

Whenever one of the parameters is changed, the previous value is displayed.

Example:

```
cmd:AX25 OFF
AX25L2V2 was ON
```

ASCII Chart

Ctrl	Dec	Hex	Code	Dec	Hex	Char	Dec	Hex	Char	Dec	Hex	Char
@	0	00	NUL	32	20	SP	64	40	@	96	60	`
A	1	01	SOH	33	21	!	65	41	A	97	61	a
B	2	02	STX	34	22	"	66	42	B	98	62	b
C	3	03	ETX	35	23	#	67	43	C	99	63	c
D	4	04	EOT	36	24	\$	68	44	D	100	64	d
E	5	05	ENQ	37	25	%	69	45	E	101	65	e
F	6	06	ACK	38	26	&	70	46	F	102	66	f
G	7	07	BEL	39	27	'	71	47	G	103	67	g
H	8	08	BS	40	28	(72	48	H	104	68	h
I	9	09	HT	41	29)	73	49	I	105	69	i
J	10	0A	LF	42	2A	*	74	4A	J	106	6A	j
K	11	0B	VT	43	2B	+	75	4B	K	107	6B	k
L	12	0C	FF	44	2C	,	76	4C	L	108	6C	l
M	13	0D	CR	45	2D	-	77	4D	M	109	6D	m
N	14	0E	SO	46	2E	.	78	4E	N	110	6E	n
O	15	0F	SI	47	2F	/	79	4F	O	111	6F	o
P	16	10	DLE	48	30	0	80	50	P	112	70	p
Q	17	11	DC1	49	31	1	81	51	Q	113	71	q
R	18	12	DC2	50	32	2	82	52	R	114	72	r
S	19	13	DC3	51	33	3	83	53	S	115	73	s
T	20	14	DC4	52	34	4	84	54	T	116	74	t
U	21	15	NAK	53	35	5	85	55	U	117	75	u
V	22	16	SYN	54	36	6	86	56	V	118	76	v
W	23	17	ETB	55	37	7	87	57	W	119	77	w
X	24	18	CAN	56	38	8	88	58	X	120	78	x
Y	25	19	EM	57	39	9	89	59	Y	121	79	y
Z	26	1A	SUB	58	3A	:	90	5A	Z	122	7A	z
[27	1B	ESC	59	3B	;	91	5B	[123	7B	{
/	28	1C	FS	60	3C	<	92	5C	\	124	7C	
}	29	1D	GS	61	3D	=	93	5D	}	125	7D	}
^	30	1E	RS	62	3E	>	94	5E	^	126	7E	~
_	31	1F	US	63	3F	?	95	5F	_	127	7F	DEL

Dec	Hex	Dec	Hex	Dec	Hex	Dec	Hex
128	80	160	A0	192	C0	224	E0
129	81	161	A1	193	C1	225	E1
130	82	162	A2	194	C2	226	E2
131	83	163	A3	195	C3	227	E3
132	84	164	A4	196	C4	228	E4
133	85	165	A5	197	C5	229	E5
134	86	166	A6	198	C6	230	E6
135	87	167	A7	199	C7	230	E7
136	88	168	A8	200	C8	232	E8
137	89	169	A9	201	C9	233	E9
138	8A	170	AA	202	CA	234	EA
139	8B	171	AB	203	CB	235	EB
140	8C	172	AC	204	CC	236	EC
141	8D	173	AD	205	CD	237	ED
142	8E	174	AE	206	CE	238	EE
143	8F	175	AF	207	CF	239	EF
144	90	176	B0	208	D0	240	F0
145	91	177	B1	209	D1	241	F1
146	92	178	B2	210	D2	242	F2
147	93	179	B3	211	D3	243	F3
148	94	180	B4	212	D4	244	F4
149	95	181	B5	213	D5	245	F5
150	96	182	B6	214	D6	246	F6
151	97	183	B7	215	D7	247	F7
152	98	184	B8	216	D8	248	F8
153	99	185	B9	217	D9	249	F9
154	9A	186	BA	218	DA	250	FA
155	9B	187	BB	219	DB	251	FB
156	9C	188	BC	220	DC	252	FC
157	9D	189	BD	221	DD	253	FD
158	9E	190	BE	222	DE	254	FE
159	9F	191	BF	223	DF	255	FF

KPC-3 Parts List

R1 - 620	R44 - 100K	C37 - 1µf Tant
R2 - 10K	R45 - 75K	C38 - 1µf Tant
R3 - 100K	R46 - 100K	C39 - .1
R4 - 4.7K	R47 - 10K	C40 - .1
R5 - 620	R48 - not installed	X1 - 7.3728 MHz
R6 - 100K	R49 - not installed	X2 - 4.4336 MHz
R7 - 100K	C1 - .01	X3 - 32.768 kHz (option)
R8 - 470K	C2 - .001	BATT - CR2032 Lithium
R9 - 47K	C3 - .001	FB1 - Small Ferrite Bead
R10 - 47K	C4 - .01	RFC1 - 10µh
R11 - 220K	C5 - .1	CR1 - 1N914
R12 - 100K	C6 - 1µf Tant	CR2 - 1N914
R13 - 10K Trimpot	C7 - 1µf Tant	CR3 - 1N914
R14 - 330	C8 - .1	CR4 - 1N914
R15 - 680K	C9 - .001	CR5 - 1N6263
R16 - 4.7K	C10 - 22pf	CR6 - 1N914
R17 - 3.3M	C11 - .1	CR7 - 1N914
R18 - 100K	C12 - 22pf	CR8 - 1N914
R19 - 47K	C13 - 68pf	CR9 - 1N914
R20 - 1M	C14 - 68pf	CR10 - 1N914
R21 - 8.45K metal film	C15 - 1µf Tant	CR11 - 1N914
R22 - 22K	C16 - .1	CR12 - not installed
R23 - 10K	C17 - 47µf Alum	CR13 - not installed
R24 - 100K	C18 - .1	Q1 - PN2907A
R25 - 10K metal film	C19 - 22pf	Q2 - PN2907A
R26 - 33K	C20 - 22pf	Q3 - PN2907A
R27 - 9.1K	C21 - .1	Q4 - PN2907A
R28 - 620	C22 - .1	Q5 - 2N7000
R29 - 1.5K	C23 - .1	VR1 - LM2936-5.0
R30 - 1.5K	C24 - 10µf Tant	U1 - DS14C88
R31 - 1.5K	C25 - .1	U2 - 74HC14
R32 - 1.5K	C26 - .1	U3 - LMC662CN
R33 - 1.5K	C27 - .1	U4 - 63B03X
R34 - 1.5K	C28 - .1	U5 - 74HC14
R35 - 47K	C29 - 10µf Non-Polar	U6 - TCM3105NL
R36 - 47K	C30 - .1	
R37 - 470K	C31 - .1	
R38 - 10K	C32 - .1	
R39 - 4.7K	C33 - .001	
R40 - 150K	C34 - .001	
R41 - 47K	C35 - .001	
R42 - 47K	C36 - .1	
R43 - 10K		

U7 - 74HC00
U8 - 74HC00
U9 - 32K SRAM
U10 - 27C512
U11 - DS1215 (option)

L1 - Green LED
L2 - Red LED
L3 - Green LED
L4 - Green LED
L5 - Green LED
L6 - Yellow LED

J1 - 2 pin header
J2 - 3 pin header
J3 - 2 pin header
J4 - not installed
J5 - wire jumper
J6 - not installed
J7 - 2 pin header
J8 - not installed
J9 - not installed
J10 - not installed
J11 - not installed
J12 - not installed

KPC-3 Parts Layout

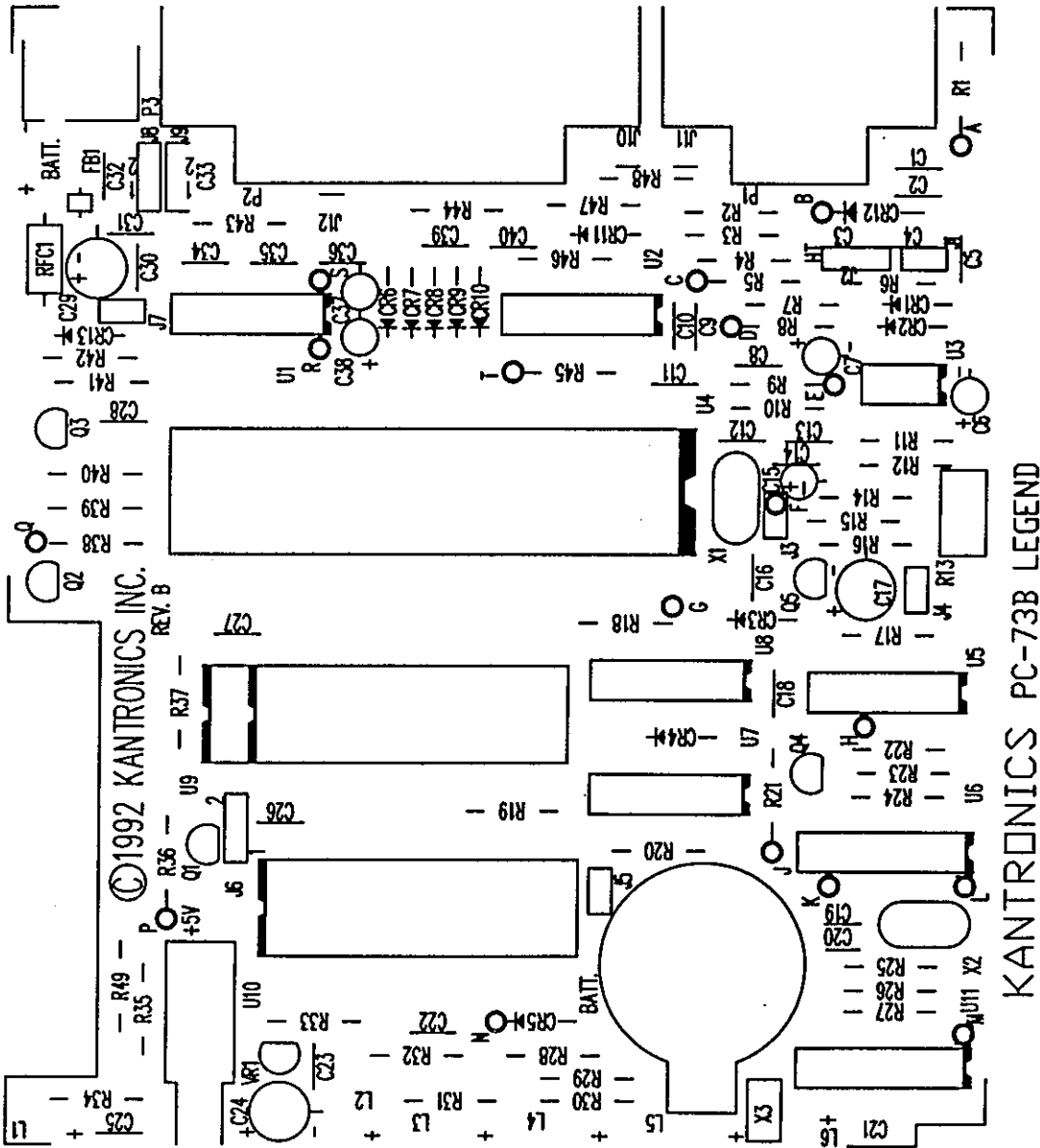

Index

G# means found in Getting Started

CAPITAL entry signifies a TNC command

Initial Cap entry signifies a command to the PBBS or KA-Node

\$, 7
<C>, 29
<CR>, 7
<Ctrl-C>, 16, 51
<D>, 29
<DM>, 29
<FRMR>, 31
<Is>, 29
<Isr>, 31
<LF>, 7
<REJ>, 31, 58
<rej>, 31, 58
<RNR>, 31
<<RNR>>, 31
<rrnr>, 31
<<rrnr>>, 31
<RR>, 31, 58
<<RR>>, 31, 58
<rr>, 31, 58
<<rr>>, 31, 58
<UA>, 29
<UI>, 29
8BITCONV, 11
8-pin mic connector, G7-G10
9-volt battery, 110

A

ABAUD, 11
Abort (ka-node), 78
abbreviations, 7
afsk
 jumper (output level), 108
 out, 97
 output levels, 99
alias, 32

allocate memory
 ka-node (numnodes), 35, 74
 maxusers, 28
 pbbs, 37, 62
ansi, 23
ascii chart, 121
assembly/disassembly tnc, 22, 104
asynchronous commands, 93
audio
 in, 97
 jumper (output level), 108
 tnc output level, 99
 out, 97
autobaud routine, G5
AUTOLF, 11
AX25L2V2, 12
ax.25 protocol, 6, 12, 29, 51
AXDELAY, 12
AXHANG, 13

B

back panel, G3
battery
 9-volt, 110
 lithium, 5, 111
baud rate
 computer, 11, 93
 radio, 25
bbs, see pbbs
bbs programs, 26
BEACON, 13
beacons, monitor, 29
bell
 connect alarm, 41
 filter, 24
BKONDEL, 13
BTEXT, 13
BUDCALLS, 14, 56
BUDLIST, 14, 56
bulletins, pbbs, 62-72
Bye, ka-node, 78
Bye, pbbs, 64

C

- cable wiring,
 - computer, G4-5, 93-96
 - power, G4
 - radio, G7-G10
- CALIBRAT, 14
- calibration/equalization, 106
- calling cq, 52
- callsign, 32
- CANLINE, 14
- CANPAC, 15
- carriage return, 19
- carrier detect
 - computer, 94, 95
 - radio, 15
- cautions, 5
- cbbs, 26
- CD, 15, 111
- change streams, 45
- CHECK, 15
- checksum, 51
- clear to send (cts), 60, 94, 95
- clock, real-time, 111
- clock, set, 20
- cmd:, 8, 51, 115
- CMDTIME, 16, 61
- CMSG, 16, 62
- COMMAND, 16, 51
- command mode, 51
- commands
 - alphabetically, 11-50
 - asynchronous, 93
 - entry, 8
 - format, 8
 - types, 9
 - structure, 8
- communications program
 - host, 83-85
 - set-up parameters, 93
 - wefax, 86-89
- computer connections, G4-G5, 93-97
- computer program, G5, 93
 - pacterm, G16-19
 - setup, 93
- configure
 - computer program, 93
 - ka-node, 74
 - pbbs, 62-63
 - remote access, 81-82
- CONLIST, 17
- CONMODE, 17, 53
- CONNECT (as a command), 17
- connect
 - multiple, 45, 55
 - on packet, G5, 17, 53
 - to ka-node, 74
 - to pbbs, 63
 - to remote access, 80-81
- connect alarm (ring), 41
- connect vs. unproto, 52
- connections
 - computer, G4, 93-97
 - hand-held radios, 100-101
 - power, G3, G4
 - radios, G7-G10, 97-98
 - rear panel, G3
- connectors
 - 21 mm power jack, G3
 - 8 pin mic connector, G8
 - db-25, G3
 - db-9, G3, G8
- CONOK, 18
- CONVERS, 18
- converse mode, 18, 27
 - calling cq, 52
 - vs. transparent mode, 60
- CPACTIME, 18
- cq, 52
- CR, 19
- cross-connect, 76-77
- CRSUP, 19
- CSTAMP, 19
- CTEXT, 19, 62
- <Ctrl-C>, 16, 51
- <ctrl-q>, 59
- <ctrl-s>, 59
- cts (clear to send), 60, 94, 95
- CWID, 20

D

.....
data bits, 93
data carrier detect (dcd)
 computer, 94, 95
 radio, 15
data set ready (dsr), 94, 95
data terminal ready (dtr), 94, 96
DAYTIME, 20
DAYTWEAK, 20, 88
DAYUSA, 20
db-9 connector, G3, G8, 97-98
db-25 connector, G3, 94
DBLDISC, 21
dcd (data carrier detect)
 computer, 94, 95
 radio, 15
default values, 41, 105
DELETE, 21
delete mail, 67
difficulty, 102-103
DIGIPEAT, 21
digipeating, 17, 54
disassembly/assembly tnc, 104
DISCONNECT, 21, 53
DISPLAY, 22
display listings, 113-114
dsr (data set ready), 94, 95
dtr (data terminal ready), 94, 96
duplex (as an asynchronous command),
 23
DWAIT, 23, 56

E

.....
ECHO, 23
Edit (pbbs messages), 65-66
eh?, 116
enter commands, 8-10
enter key, 19
enter your message (pbbs), 64
equalization/calibration, 106
equalization jumper, 108
erase messages, pbbs, 67
error messages, 115

ESCAPE, 23
expand ram, 110
external reset, 96, 98

F

.....
factory defaults, 41
FILTER, 24
flag, 51
FLOW, 24
flow control, 59-60
 dsr/dtr, 96
 hardware (rts/cts), 60
 software, 59
forwarding, pbbs messages, 65, 71
FRACK, 24, 57
frame, 51
front panel, G2
FULLDUP, 25

G

.....
gateway, 55
getting out of transparent, 61
ground, 5
 computer (sg), 95
 radio, 98
guard time, 16, 61

H

.....
hand-held radios, 100-101
hand-held jumper, 108
handshaking (rts/cts), 60
hard reset, 105, 108
hardware flow control, 60
HBAUD, 25
header (packet), 51
headers (pbbs), 38, 63
HEADERLN, 25, 54
HELP, 25
help, in case of difficulty, 102-103
Help, ka-node, 78
Help, pbbs, 66
hex, 7, 9

HID, 26
host mode, 83-85

I

.....
I/O, 7
icom radios, G9, 100
ID, 26
id, cw, 20
indicators, front panel, G2
in case of difficulty, 102-103
initialize, 105
interference (rfi), 3-4
INTERFACE, 26

J

.....
Jheard, 66, 78
jumpers, 108-109
 afsk output, 99, 108
 connector for external signal, 109
 dsr/cts, 109
 dtr/dsr, 109
 dtr/rts, 109
 equalization, 106, 108
 external signal select, 108
 hard reset, 105, 108
 ht modification, 108
 ram expansion, 108
 real-time clock, 108
 watch dog timer, 107, 108

K

.....
K, 27
ka-node, 73-80
 automatic disconnect, 27, 76
 force disconnect, 22
 number of circuits, 35
 set call, 33
 set ntext, 35
 time out, 27
kenwood radios, G10, 101
key-up delay, 48
Kill pbbs messages, 67

kiss mode, 26, 90-92
KM (kill mine, pbbs), 67
KNTIMER, 27, 76

L

.....
LCOK, 27
LCSTREAM, 27
LEDS, 27, 111
leds, G2
LFADD, 27
LFSUP, 28
line feed, 11, 27, 28
lithium battery, 5, 111
List messages, pbbs, 66-67, 70
LLIST, 28
LM (List Mine, pbbs), 67
low power, 111

M

.....
mailbox, see pbbs
MALL, 28, 56
MAXFRAME, 28, 57
MAXUSERS, 28, 55
MBEACON, 29
mbl, 26
MCOM, 29
MCON, 30, 53, 55, 56
messages from the kpc-3, 115
messages pbbs, 62-72
MHCLEAR, 30
MHEARD, 30
mic connector, G7-G10
modem break, 61
MONITOR, 30, 52, 55, 56
monitoring beacons, 29
monitoring packet, 30, 52
MRESP, 31
MRPT, 32, 54
MSTAMP, 32
multi-connects, 55
MYALIAS, 32, 54
MYCALL, 32
MYNODE, 33, 74

MYPBBS, 33, 62
MYREMOTE, 33, 81

N

NDHCLEAR, 33
NDHEARD, 34
NDWILD, 34, 74
NEWMODE, 34
Nodes, 80
nodes heard, 34
NOMODE, 35, 53
NTEXT, 35
nts messages, 68-69
NUCR, 35
NULF, 35
NUMNODES, 35, 74

O

options, 110

P

PACLEN, 36, 53, 57
pacterm manual, G16-G19
PACTIME, 36
panels
 back, G3
 front, G2
parameter types,
 n (range), 9
 n (\$00 - \$FF), 9
 flags, 10
 callsigns, 10
 text, 10
PARITY, 36
parity, 93
PASS, 37
PASSALL, 37
password, 42
PBBS, 37, 62
pbbs, 62-72
 allocate memory, 37
 force disconnect, 22

 renumber msgs, 37, 62
 remote access, 71
 set call, 33
 set ptext, 39
 status, G2
 switch connect, 16, 62
PBHEADER, 38, 63
PBLO, 38, 63
PBPERSON, 38, 63
PERSIST, 38, 56, 90
personal mailbox, see pbbs
PID, 39
poll, 58
power
 applied through db-25, 96
 applied through db-9, 98
 cable, G4
 jack, G3
 low, 111
 requirements, 112
precautions, 5
press (*) to set baud rate, G5
problems, 102-103
programs
 computer, G5, 93
 host, 83-85
 pacterm, G16-19
 terminal, G5, 93
 wefax, 86-89
protocol, see ax.25 protocol
PTEXT, 39
PTT, 97
push-to-talk, 97

R

R: lines, 38, 63
radio connections, G7-G10, 97-98
 hand-held, 100-101
radio frequency interference, 3-4
ram expansion, 110
 512K jumper, 108
Read messages, pbbs, 67
real-time clock, 111
 jumper, 108

rear panel, G3
 receive audio, 97
 receive data (rxd), 94, 95
 receive volume, G7
REDISPLAY, 39
 remote access, 81-82
 pbbs sysop, 71
 set call, 33
 set rtext, 42
RELINK, 40, 58
 repair procedures, 2
 request to send (rts), 60, 94, 95
RESET, 40
 reset
 external, db-9, 98
 external, db-25, 96
 hard, 105, 108
 soft, 40
RESPTIME, 41
RESTORE default, 41
 retries ax.25 level 2, version 1 vs.
 version 2, 58
RETRY, 41, 52
 return key, 19
 return/repair, 2
 reverse forwarding (pbbs), 71
 rfi, 3-4
RING, 41
 rli, 26
RM (Read Mine, pbbs), 68
RNRTIME, 42
 round table discussions, 56
 rs-232 wiring, G4-G5, 93-96
RTEXT, 42, 81
 rts (request to send), 60, 94, 95
 rts/cts handshaking, 60
 rxd (receive data), 59, 94, 95

S

.....
SCREENL, 43
 Send (pbbs message), 68
SENDPAC, 43, 53
 serial port, 93
 set clock, 20

set-up
 computer program, 93
 ka-node, 74
 pbbs, 62-72
 remote access, 81-82
 terminal program, 93
 service, 2
 sg (signal ground), 94, 95
 signal ground (sg), 94, 95
 skewed wefax pictures, 20, 88
SLOTTIME, 43, 56, 90
 software carrier detect (radio), 15
 software flow control, 59
 specifications, 112
 squelch
 radio control, G7
 connection, 97
 ssid, 32
START, 43, 59
STATSHRT, 43, 55
STATUS, 44, 55
 status, short, 43
 stay option (ka-node), 78
STOP, 44, 59
 stop bits, 93
STREAMCA, 45, 56
STREAMEV, 45, 55
STREAMSW, 45, 55
 subject line (pbbs), 64
SUPCALLS, 45
SUPLIST, 46
 switch connect to mailbox, 16, 62
SWP, 46
 sysop, remote, 71, 81-82

T

.....
 tcp/ip, 90
 technical specifications, 112
 terminal program, G5, 93
 host, 83-85
 pacterm, G16-19
 set-up parameters, 93
 wefax, 86-89

test
 in case of difficulty, 102-103
 hard reset jumper, 105, 108
time (of day), 20
time out, ka-node, 27
timing (packet), 56
tnc
 computer connection, G4-G4, 93-96
 definition, 6, 51
 radio connection, G7-G10, 97-98,
 100-102
TRACE, 46
TRANS, 47
transmit audio, 97
transmit, enable/disable, 50
transmit data (txd), 94, 95
transparent mode,
 getting out, 61
 using software flow control, 59
 vs. convers mode, 60
TRFLOW, 47, 59
TRIES, 47
trouble, 102-103
tuning wefax, 87
txd (transmit data), 59, 94, 95
TXDELAY, 48, 57
TXFLOW, 48, 59

U

.....
unconnected, 52
UNPROTO, 48
unproto mode, 52, 56
upgrading, 105
USERS, 49, 55
using
 ka-node, 74-80
 pbbs, 62-72

V

.....
VERSION, 49
via, 17, 48, 54
voice repeater, 12, 13
volume
 receive (radio), G7
 tnc output level, 99

W

.....
warranty, 1
watch dog timer, 107
watch dog jumper, 108
WEFAX, 49, 88
Wefax Mode, 86-89
 frequencies, 87
 skewed picture, 20, 88
 tuning, 87
 writing a program, 88-89
wiring
 to computer, G4-G5, 93-96
 to power, G4
 to radio, G7-G10
word length, 93

X

.....
Xconnect (ka-node), 76-77, 80
XFLOW, 49, 59
XMITOK, 50
XOFF, 50, 59
XON, 50, 59
xxxxxx-n, 10

Y

.....
yaesu radios, G8, 101

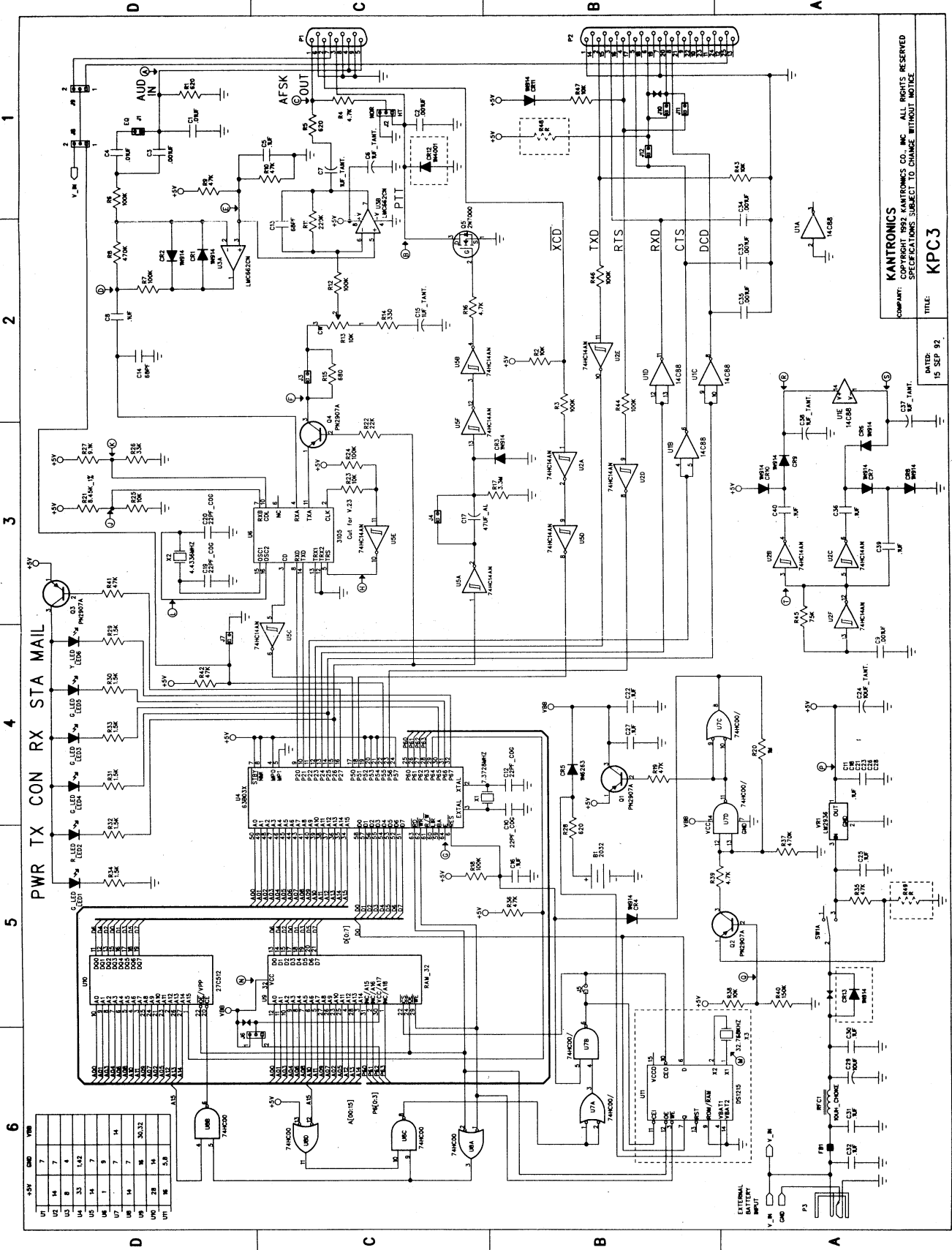

PWR TX CON RX STA MAIL

UNIT	QTY	DESCRIPTION
U1	1	74HC00
U2	1	74HC04
U3	1	74HC14
U4	1	74HC20
U5	1	74HC595
U6	1	74HC00
U7	1	74HC04
U8	1	74HC14
U9	1	74HC20
U10	1	74HC595
U11	1	74HC00
U12	1	74HC04
U13	1	74HC14
U14	1	74HC20
U15	1	74HC595
U16	1	74HC00
U17	1	74HC04
U18	1	74HC14
U19	1	74HC20
U20	1	74HC595
U21	1	74HC00
U22	1	74HC04
U23	1	74HC14
U24	1	74HC20
U25	1	74HC595
U26	1	74HC00
U27	1	74HC04
U28	1	74HC14
U29	1	74HC20
U30	1	74HC595
U31	1	74HC00
U32	1	74HC04
U33	1	74HC14
U34	1	74HC20
U35	1	74HC595
U36	1	74HC00
U37	1	74HC04
U38	1	74HC14
U39	1	74HC20
U40	1	74HC595
U41	1	74HC00
U42	1	74HC04
U43	1	74HC14
U44	1	74HC20
U45	1	74HC595
U46	1	74HC00
U47	1	74HC04
U48	1	74HC14
U49	1	74HC20
U50	1	74HC595
U51	1	74HC00
U52	1	74HC04
U53	1	74HC14
U54	1	74HC20
U55	1	74HC595
U56	1	74HC00
U57	1	74HC04
U58	1	74HC14
U59	1	74HC20
U60	1	74HC595
U61	1	74HC00
U62	1	74HC04
U63	1	74HC14
U64	1	74HC20
U65	1	74HC595
U66	1	74HC00
U67	1	74HC04
U68	1	74HC14
U69	1	74HC20
U70	1	74HC595
U71	1	74HC00
U72	1	74HC04
U73	1	74HC14
U74	1	74HC20
U75	1	74HC595
U76	1	74HC00
U77	1	74HC04
U78	1	74HC14
U79	1	74HC20
U80	1	74HC595
U81	1	74HC00
U82	1	74HC04
U83	1	74HC14
U84	1	74HC20
U85	1	74HC595
U86	1	74HC00
U87	1	74HC04
U88	1	74HC14
U89	1	74HC20
U90	1	74HC595
U91	1	74HC00
U92	1	74HC04
U93	1	74HC14
U94	1	74HC20
U95	1	74HC595
U96	1	74HC00
U97	1	74HC04
U98	1	74HC14
U99	1	74HC20
U100	1	74HC595

KANTRONICS
 COMPANY: COPYRIGHT 1992 KANTRONICS CO., INC. ALL RIGHTS RESERVED
 SPECIFICATIONS SUBJECT TO CHANGE WITHOUT NOTICE.
 TITLE: KPC3
 DATE: 15 SEP 92